

# Suministros Salanguera

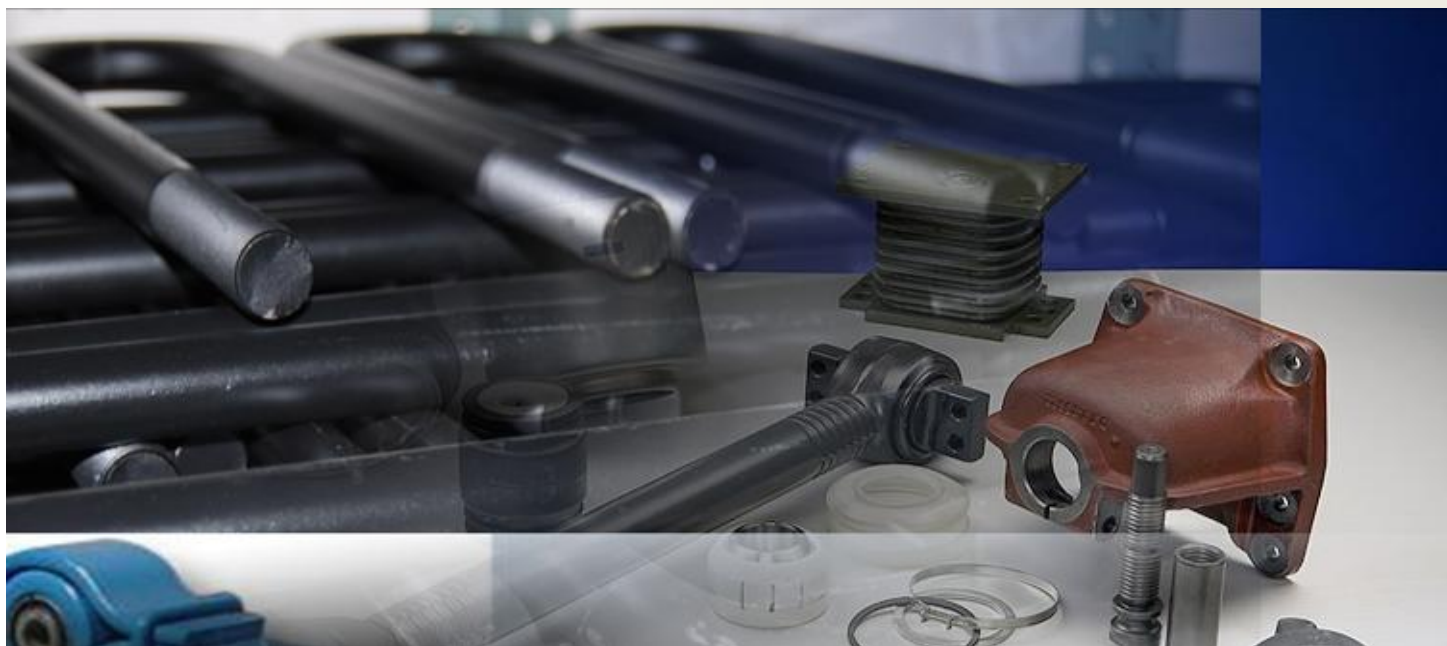



























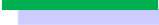

ACCESORIOS CAMIONES, PLATAFORMAS Y LIGEROS

Suspensions Parts Truck & Trailer

Suministros Salanguera  
C/ Daniel Mangrané, 8  
43590-Jesús-Tortosa  
Tarragona-España  
Tel./fax.: 977 500 001

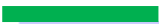
[www.suministrossalanguera.es](http://www.suministrossalanguera.es)  
[salanguera@suministrossalanguera.es](mailto:salanguera@suministrossalanguera.es)

# INDICE

DAF .....	01-14	
IVECO .....	15-35	
MAN .....	36-54	
MERCEDES .....	55-89	
R.V.I .....	90-109	
SCANIA .....	110-122	
VOLVO .....	123-140	
FORD .....	141-143	
ISUZU .....	144-145	
LAND ROVER .....	146-147	
MITSUBISHI .....	148-150	
NISSAN .....	151-157	
SUZUKI .....	158-159	
TOYOTA .....	160-161	
BPW .....	162-176	
FRUEHAUF-SMB .....	177-181	
KÄSSBOHRER .....	182-183	
LECIÑENA-GIGANT-WEWELER .....	184-189	
MONTENEGRO .....	190-193	
PEPIN .....	194-195	
PRIMBALL .....	196-197	
ROR-MERITOR .....	198-204	
GALUCHO .....	205-206	
SAF-SAUER .....	207-210	
TRAILOR .....	211-212	
ARANDELAS Y CAPUCHINOS DE 10 Ø .....	213-214	
SUPLEMENTOS DE ABARCÓN, CADENAS ELEVADOR ....	215-216	
TORNILLOS Y TUERCAS .....	217-220	

# Suministros Salanguera

DAF

Ref. Salanguera	Ref. Or.	Descripción	Modelo	
BPDA-01		Balancín  Silent-bloc Ø50 interior SP-9021	DAF BPW TRABOSA	
BB-4032	0643499	Bulón ballesta Eje delantero Eje trasero Ø35 x 160	F 210 F 230 F 2500 F 2700 F 2800 F 2900 F 3200 F 3300 F 3600	
BB-4033	0655129	Bulón gemela trasera  Ø42 x 148	75 CF 85 CF 95 XF 95 XF 530 CF 75 CF 75IV CF 85 CF 85IV F 28 F 36	
BB-4034	0299039	Bulón ballesta Eje trasero Ø32 x 158	65 CF 75 CF 85 CF 95 XF 95 XF 530 CF 75 CF 85 CF 85IV F 1900	
BB-4035	0389071	Bulón ballesta Eje delantero Ø26 x 136	65 CF 75 CF 85 CF 95 XF 95 XF 530 N 28 TT 2100 F 65 F 75	
BB-4037	0089781	Bulón ballesta  Ø30 x 139	F 1700 F 1900	
BB-4038	0763009	Bulón ballesta  M20/250 x Ø30 x 152	F 1700 F 1900	

Ref. Salanguera	Ref. Or.	Descripción	Modelo	
BB-4039	0645232	Bulón ballesta Ø25 x 136	F 1600 F 1800 F 2100 F 2300 F 2500 F 2700 SB 2100 TB 2100	
BB-4040	0645231	Bulón ballesta Engrase invertido Ø25 x 136	F 1600 F 2100 F 2300 F 2500 F 2700	
BB-4040/1	0299812	Bulón ballesta Ø25 x 64,5	65 CF 75 CF 85 CF 95 XF 95 XF 530 CF 65 CF 75 CF 75IV CF 85	
BB-4040/2	0645233 171199 0645234	Bulón ballesta Ø35 x 160	F 1900 F 2100 F 2300 F 2500 F 2800 F 2900 F 3200 F 3300 F 3600	
BP-5001	0317716250	Bulón balancín C/T Ø50 x 230  Tuerca: M42/300		
CAPUCHINOS:	CP-160802411 CP-161002411 CP-161202411 CP-161402411 CP-161602411 CP-161802411 CP-162002411	16 x 80 16 x 100 16 x 120 16 x 140 16 x 160 16 x 180 16 x 200	Diámetro: Ø16  Ancho cabeza: Ø24  Altura cabeza: 11mm.	

Ref. Salanguera	Ref. Or.	Descripción	Modelo	
CB-253277	0645245	Casquillo ballesta Ø25 x Ø32 x 77,5	F 1600 F 1800 F 2100 F 2300 F 2500 F 2700 SB 210 SB 2100	
CB-354297	0631075 0643384 0659666	Casquillo ballesta Ø35x Ø42 x 97	F 2800 F 2900 F 3200 F 3300 F 3600 N 2800	
CB-425185		Casquillo ballesta Ø42x Ø51 x 85		
CB-345297		Casquillo ballesta Ø34x Ø52 x 97		
100311005		Casquillo ballesta Ø34x Ø52 x 97 c/tórica		
CB-319375	0679254	Ø31 x 39 x 75,5 Acero	65 CF 75 CF 85 CF	
CB-263152	0679253	Ø26 x 31 x 52,5 Bronce	95 XF 95 XF 530	
RT-263511	1236238	Ø26 x 35 x 11 Reten	F 28 F 36 N 28 TT 2100	
26.31.75			F 65	
CB-374995	0266411	Ø37 x 49 x 95,5 Acero	65 CF 75 CF 85 CF	
CB-323772	0266412	Ø32 x 37 x 72,5 Bronce	95 XF 95 XF 530	
RT-324511	1261846	Ø32 x 45 x 11 Reten	CF 75 CF 85 CF 85 IV	
32.49.95			F 65	
CB-374975	0092960	Ø37 x 49 x 75,5 Acero	75 CF 85 CF 95 XF	
CB-323752	0092961	Ø32 x 37 x 52,5 Bronce	CF 75 CF 75 IV	
RT-324511	1261846	Ø32 x 45 x 11 Reten	CF 85 CF 85 IV	
32.49.75			F 75 F 85	

Ref. Salanguera	Ref. Or.	Descripción	Modelo	
SB-8207	1401681	Silent-bloc PIN Ø16/Ø45 x 84 x 140	LF 45 FA 45.150 LF 45 FA 45.170 LF 45 FA 45.180 LF 45 FA 45.220	
SB-8208	1401539	Silent-bloc ballesta Ø16 x 45 x 75 x 82	LF 45 LF 45 IV LF 55 LF 55 IV	
SB-8209	1401515	Silent-bloc PIN Ø16/Ø49 x 82 x 143	F 55 LF 45 LF 45 IV LF 55 LF 55 IV	
SB-8210	1401516	Silent-bloc ballesta Ø16 x 49 x 75 x 82	F 55 LF 45 LF 45 IV LF 55 LF 55 IV	
SB-8209/1	0654792	Silent-bloc PIN Ø34/Ø50 x 98 x 144	75 CF 85 CF 95 XF 95 XF 530 CF 75 CF 75 IV CF 85 CF 85 IV F 28 F 36	
SB-8211	1401487	Silent-bloc PIN Ø18/Ø52 x 97 x 157	CF 65 CF 65 II CF 65 IV LF 55 LF 55 IV	
SB-8212	1401489	Silent-bloc ballesta Ø18 x 52 x 97	LF 55 LF 55 IV CF 65 CF 65 II CF 65 IV	

Ref. Salanguera	Ref. Or.	Descripción	Modelo	
SB-8203	1671219	Silent-bloc ballesta Ø24 x 61 x 86	CF 75 CF 75 IV CF 85 CF 85 IV XF 105 XF 95	
SB-8205	1357764 1357724	Silent-bloc ballesta Ø24 x 63 x 70 x 86	65 CF 75 CF 85 CF CF 65 CF 75 CF 75 IV CF 85 CF 85 IV LF 55	
SB-8205/1	1368283	Silent-bloc ballesta Eje delantero Eje trasero Ø24 x 62 x 106	65 CF 75 CF 85 CF CF 65 CF 75 CF 75 IV CF 85 CF 85 IV XF 105	
SB-8215	1681114	Silent-bloc PIN Ø59,5 x 18/22 x 128	CF 85 CF 85 IV XF 105 XF 95	
		MERCEDES-BENZ: 0003330217 A0003330217		
SB-8204	0361477	Placa separación Ø74,5 x 17	65 CF 75 CF 85 CF 95 CF 95 XF 530 CF 75 CF 85 CF 85 IV F 28	
SB-8081	0361478	Placa separación Ø85 x 17	75 CF 85 CF 95 CF F 75 F 85 F 95 F 1900 F 2100 F 2300	
		RVI: 5000731430		
SB-8216	1628826	Placa separación M6/70 x 90 x 13	65 CF 75 CF 85 CF CF 65 CF 75 IV CF 85 CF 85 IV XF 95 XF 105	



Ref. Salanguera	Ref. Or.	Descripción	Modelo	
SB-8300DAF	1779767 1699564	Apoyo elástico ballesta h: 205	CF 75 CF 75 IV CF 85 CF 85 IV XF 105 XF 95	
24.16.0001	1400396 ACHF431	Silent-bloc barra Estabilizadora  Ø16 x 36,5 x 48	F 45 LF 45 LF 55	
24.16.0002	1287999 1273279	Silent-bloc barra Estabilizadora  Ø16 x 46,5 x 50	65 CF 75 CF 85 CF 95 XF 95 XF 530 CF 65 CF 75 CF 75 IV CF 85	
24.16.0003	0293898	Silent-bloc barra Estabilizadora  Ø20,5 x 55 x 56	65 CF 75 CF 85 CF 95 XF 95 XF 530 CF 65 CF 75 CF 75 IV CF 85	
24.16.0004	0295726	Silent-bloc barra Estabilizadora  Ø20,5 x 55 x 55	65 CF 75 CF 85 CF 95 XF 95 XF 530 CF 85 F 65 F 75 F 85	
24.16.0005	1283618	Silent-bloc barra Estabilizadora  Ø20 x 60 x 59,5	65 CF 75 CF 85 CF 95 XF 95 XF 530 CF 65 CF 75 CF 75 IV CF 85	
24.16.0006	0268043	Silent-bloc barra Estabilizadora  Ø25,5 x 35 x 23	1100 1300 65 CF F 65 F 75 F 85 F 95 F 1100 F 1300	

Ref. Salanguera	Ref. Or.	Descripción	Modelo	
24.16.0007	0274651	Silent-bloc barra Estabilizadora  Ø50 x 60 x 23,5	75 CF 85 CF 95 XF 95 XF 530 CF 85 F 75 F 85 F 95 - F 2300	
24.16.0008	0274650	Silent-bloc barra Estabilizadora  Ø40,5 x 50 x 23,5	65 CF 75 CF 85 CF 95 XF 95 XF 530 F 65 F 75 F 85 F 95	
24.16.0009	0371465	Silent-bloc barra Estabilizadora  Ø25,5 x 46 x 25	F 2100 F 2300 F 2500 F 2700 F 2800 F 2900 F 3200 F 3300 F 3600	
24.16.0010	0277171	Silent-bloc barra Estabilizadora  Ø30 x 55 x 27	F 2100 F 2300 F 2500 F 2700 F 2900 F 3200 F 3300 F 3600	
24.16.0012	0259526 0299108	Silent-bloc barra Estabilizadora  Ø25,5 x 45,5 x 49	F 95 F 1600 F 1700 F 2100 F 2300 F 2500 F 2700 F 2800 F 2900	
24.16.0013	0299106 0290825 0259524	Silent-bloc barra Estabilizadora  Ø30,5 x 56 x 57	65 CF 75 CF 85 CF 95 XF 95 XF 530 BUS CF 75 CF 75 IV CF 85	
24.16.0015	0268045	Silent-bloc barra Estabilizadora  Ø50 x 70 x 75	65 CF 75 CF 85 CF 95 XF 95 XF 530 CF 75 CF 75 IV CF 85 CF 85 IV	

Ref. Salanguera	Ref. Or.	Descripción	Modelo	
24.16.0016	0268044	Silent-bloc barra Estabilizadora  Ø55 x 70 x 75	65 CF 75 CF 85 CF 95 XF CF 85 CF 85 IV F 28 - F 39 N 28 - TT 2100	
24.16.0017	0291280	Silent-bloc barra Estabilizadora  Ø37 x 57,5 x 66	1100 1300 F 1100 F 1300 F 28 F 36 N 28 TT 2100	
24.16.0018	0538329	Silent-bloc barra Estabilizadora  Ø41 x 76 x 60	65 CF 75 CF 85 CF F 28 F 36 N 28 TT 2100 F 65 F 75 F 85	
24.16.0019	0278040	Silent-bloc barra Estabilizadora  Ø38,5 x 72,5 x 52	F 5 F 27	
24.16.0020	0293417	Silent-bloc barra Estabilizadora  Ø40 x 70 x 37	F 2100 F 2300 F 2500	
24.16.0021	0096109	Silent-bloc barra Estabilizadora  Ø45 x 76 x 60	75 CF 85 CF 95 XF 95 XF 530 F 28 F 36 N 28 TT 2100 F 75 F 85	
24.16.0022	0763523	Silent-bloc barra Estabilizadora  Ø51 x 74,5 x 60	75 CF 85 CF 95 XF CF 75 CF 75 IV CF 85 CF 85 IV F 28 F 36 N 28	

Ref. Salanguera	Ref. Or.	Descripción	Modelo	
24.16.0023	0366351	Silent-bloc barra Estabilizadora  Ø64 x 84,5 x 60	75 CF 85 CF - 95 XF 95 XF 530 CF 75 CF 75 IV CF 85 CF 85 IV F-28 - F 36	
24.16.0025	0558864	Silent-bloc barra Estabilizadora  Ø60 x 86 x 60	65 CF 75 CF 85 CF 95 CF 95 XF 530 CF 65 CF 75 CF 75 IV CF 85	
24.16.0026	1732887 1291233	Silent-bloc barra Estabilizadora  Ø43x 61 x 60	75 CF 85 CF 95 XF 95 XF 530 CF 75 CF 75 IV CF 85 CF 85 IV F 75	
24.16.0027	1288000	Silent-bloc barra Estabilizadora  Ø38,5 x 61 x 60	65 CF 75 CF 85 CF 95 XF CF 65 CF 75 CF 75 IV CF 85 CF 85 IV	
24.16.0028	0299109 0259525	Silent-bloc barra Estabilizadora  Ø37 x 57,5 x 66	F 1600	
24.16.0029	0259523 0299110	Silent-bloc barra Estabilizadora  Ø51 x 76	BUS F 5 - F 27 F 28 - F 36 N 28 TT 2100 65 CF 85 CF CF 65 CF 85	
24.16.0038	0010761	Silent-bloc barra Estabilizadora  Ø39,5 x 66	65 CF F 65 F 95 F 1600 F 1900 F 2100 F 2300 F 2500 F 2700	

Ref. Salanguera	Ref. Or.	Descripción	Modelo	
24.16.0030	1400147	Silent-bloc barra Estabilizadora  Ø34 x 57,5	CF 65 CF 65 II CF 65 IV LF 45 LF 55 LF 55 BODY LF 55 IV LF 55 IV MEX	
24.16.0031	1402562	Silent-bloc barra Estabilizadora  Ø27,5 x 52,5	LF 45 LF 45 II LF 45 IV	
24.16.0032	1323838	Silent-bloc barra Estabilizadora  Ø48 x 83 x 75	65 CF 75 CF 85 CF 95 CF 95 XF 530 CF 65 CF 75 CF 75 IV CF 85	
24.16.0033	1323839	Silent-bloc barra Estabilizadora  Ø55 x 83 x 75	65 CF 75 CF 85 CF 95 XF CF 75 CF 75 IV CF 85 CF 85 IV F 28 - F 36	
24.16.0034	0298498	Silent-bloc barra Estabilizadora  Ø60 x 95 x 80	BUS 75 CF 85 CF F 28 F-36 N 28 TT 2100 F 75 F 85 F 95	
24.16.0035	0281007	Silent-bloc barra Estabilizadora  Ø45 x 95 x 70/80	85 CF F 2100 SB 220 SB 225 SBG 220 BUS 865 AVM DB 250	
24.16.0036	0298497	Silent-bloc barra Estabilizadora  Ø50 x 95 x 80	F 110 F 1300 MBG 200 SB 220 SB 230 SB 2300 SB 2700 SBG 220	

Ref. Salanguera	Ref. Or.	Descripción	Modelo	
24.16.0037	1401850	Silent-bloc barra Estabilizadora  Ø25 x 54	LF 45	
24.16.0038	1402572	Silent-bloc barra Estabilizadora  Ø40 x 40	LF 45	
24.16.0039	1402590	Silent-bloc barra Estabilizadora  Ø48 x 54	CF 65 CF 65 II CF 65 IV F 55 LF 55	
24.16.0040	1402587	Silent-bloc barra Estabilizadora  Ø46 x 54	CF 65 CF 65 II CF 65 IV LF 55 LF 55 BODY LF 55 IV LF 55 IV MEX	
24.16.0041	1402571	Silent-bloc barra Estabilizadora  Ø35 x 40	LF 45 LF 45 IV FT 95 500	
24.16.0042	1700604	Silent-bloc barra Estabilizadora  Ø35	LF 45 LF 45 IV	
24.16.0043	1700605	Silent-bloc barra Estabilizadora  Ø40	LF 45 LF 45 IV	

Ref. Salanguera	Ref. Or.	Descripción	Modelo	
100306001	0080521 1368270 1390932 1361651 2001492 1793875	Tirante en V  L: 609mm. Tubo de: Ø50 Kit puntas: 100306002 Kit central: 100306003	CF 65 IV CF 75 IV CF 85 IV LF 55 IV XF 105	
100306002	1376729	Kit reparación puntas  Bola: Ø75mm Taladro: Ø23mm Distancia Ø/Ø: 152mm Largo: 24mm	65 CF 75 CF 85 CF 95 CF 95 CF 530 CF 65 CF 75 CF 75 IV CF 85	
100306003	1676776	Kit reparación central  M24x1,5/Ø108x68	65 CF 75 CF 85 CF CF 65 CF 75 CF 75 IV CF 85 II CF 85 IV LF 55	
100306006	0649819 1620437 1793877	Tirante en V  L: 603mm. Tubo de: Ø60  Kit puntas: 100306007 Kit central: 100306008	75 CF 85 CF 95 CF 95 XF 530 CF 75 CF 75 IV CF 85 CF 85 IV F 28 F 36	
100306007	0646321 1208071 VOLVO: 274056 276192 SCANIA: 1104336	Kit reparación puntas  Bola: Ø95mm Taladro: Ø23mm Distancia Ø/Ø: 152mm Largo: 35mm	75 CF 85 CF 95 XF 95 XF 350 BUS CF 75 CF 75 IV CF 85 CF 85 IV	
100306008	0696320 VOLVO: 273706 276191 MAN: 81432706080	Kit reparación central  M24x1,5/Ø90x59	75 CF 85 CF 95 XF 95 XF 530 CF 75 CF 75 IV CF 85 CF 85 IV F 28 F 36	
100306009	1620436 1361652 1793876	Tirante en V  L: 608mm. Tubo de: Ø50  Kit puntas: 100306010 Kit central: 100306008	75 CF 85 CF CF 75 CF 75 IV CF 85 CF 85 II CF 85 IV F 85	

Ref. Salanguera	Ref. Or.	Descripción	Modelo
100306010	0698724	Kit reparación puntas Bola: Ø85mm Taladro: Ø23mm Distancia Ø/Ø: 152mm Largo: 35mm	65 CF 75 CF 85 CF 95 XF 95 CF 530 CF 75 CF 75 IV CF 85











IVECO

Ref. Salanguera	Ref. Or.	Descripción	Modelo	
BB-4061		Bulón ballesta Ø35 x 152		
BB-4062	8581881	Bulón ballesta Ø24 x 130		
BB-4063		Bulón ballesta Ø16 x 120		
BB-4064		Bulón ballesta Ø30/35 x 152		
BB-4067	8161191	Bulón ballesta M20/150 X 161	EUROTRAKKER CURSOR EUROTRAKKER EUROTECH EUROSTAR TRAKKER EUROTECH CURSOR EUROSTAR CURSOR STRALIS	
CAPUCHINOS:	CP-10090206 CP-10100206 CP-10120206 CP-10140206 CP-10160206 CP-10180206	10 x 90 10 x 100 10 x 120 10 x 140 10 x 160 10 x 180	Diámetro: Ø10 Ancho cabeza: Ø20 Altura cabeza: 6,5mm	
CAPUCHINOS:	CP-120802028 CP-121002028 CP-121202028 CP-121402028 CP-121602028 CP-121802028	12 x 80 12 x 100 12 x 120 12 x 140 12 x 160 12 x 180	Diámetro: Ø12 Ancho cabeza: Ø20 Altura cabeza: 28mm	

Ref. Salanguera	Ref. Or.	Descripción	Modelo	
CAPUCHINOS:	CP-121002530	12 X 100	Diámetro: Ø12	
	CP-121202530	12 X 120	Ancho cabeza: Ø25 Altura cabeza: 30mm	
CAPUCHINOS:	CP-122002015	12 x 200	Diámetro: Ø12	
	CP-122202015	12 x 220	Ancho cabeza: Ø20	
	CP-122402015	12 x 240	Altura cabeza: 15mm	
CAPUCHINOS:	CP-140802224	14 x 80	Diámetro: Ø14	
	CP-141002224	14 x 100	Ancho cabeza: Ø22	
	CP-141202224	14 x 120	Altura cabeza: 24mm	
	CP-141402224	14 x 140		
CAPUCHINOS:	CP-161802512	16 x 180	Diámetro: Ø16	
	CP-162002512	16 x 200	Ancho cabeza: Ø25	
	CP-162202512	16 x 220	Altura cabeza: 12mm	
	CP-162402512	16 x 240		
	CP-162602512	16 x 260		
	CP-162802512	16 x 280		
	CP-163002512	16 x 300		
	CP-163202512	16 x 320		
CP-163402512	16 x 340			
CASQUILLOS:	CB-243060	Ø24 x Ø30 x 60		
	CB-243070	Ø24 x Ø30 x 70		
	CB-243080	Ø24 x Ø30 x 80		
	CB-243090	Ø24 x Ø30 x 90		
	CB-344270	Ø34 x Ø42 x 70		
	CB-354590	Ø35 x Ø45 x 90		

Ref. Salanguera	Ref. Or.	Descripción	Modelo	
I-380E34.01	8138566	Silleta balancín Ø180 X Ø195 X 275	AD TRAKKER AT TRAKKER EUROTRAKKER CURSOR EUROTRAKKER M720E52WT	
I-380E34.03	8138275	Semi-eje: Ø120 - Ø122	EUROTRAKKER EUROTRAKKER CURSOR AD TRAKKER AT TRAKKER AD TRAKKER 2007 AT TRAKKER 2007 AD TRAKKER E4 AT TRAKKER E4	
I-380E34.14	1172083	TORNILLOS M16 x 70mm.	EUROTRAKKER EUROTRAKKER CURSOR AD TRAKKER AT TRAKKER AD TRAKKER 2007 AT TRAKKER 2007 AD TRAKKER E4 AT TRAKKER E4	
I-380E34.07	8138307	Pista rodamiento Interior: Ø122 x Ø180 x 63	AD TRAKKER AT TRAKKER EUROTRAKKER CURSOR EUROTRAKKER	
I-380E34.08	8138308	Pista rodamiento Exterior: Ø120 x Ø180 x 40	AD TRAKKER AT TRAKKER EUROTRAKKER CURSOR EUROTRAKKER M720E52WT	
I-380E34.11	8138507	Arandela reglaje 0,2mm	AD TRAKKER AT TRAKKER EUROTRAKKER CURSOR	
I-380E34.10	8138508	Arandela reglaje 0,5mm	EUROTRAKKER EUROTRAKKER M720E52WT	
I-380E34.09	8138509	Arandela reglaje 1,0mm		
I-380E34.04	8138327 2997054	Tapa de silleta M18/1,5 x Ø190 x 52	AD TRAKKER AT TRAKKER EUROTRAKKER CURSOR EUROTRAKKER	

Ref. Salanguera	Ref. Or.	Descripción	Modelo	
I-380E34.13	17299681	Junta tapa silleta 367mm x 5,33	AD TRAKKER AT TRAKKER EUROTRAKKER CURSOR EUROTRAKKER	
I-380E34.12	17298081	Junta tórica 120 x 125 x 5	AD TRAKKER AT TRAKKER EUROTRAKKER CURSOR EUROTRAKKER	
I-380E34.02	40101540 41296800	Retén del semi-eje  Ø166 x Ø186 x 15/23	AD TRAKKER AT TRAKKER EUROTRAKKER CURSOR EUROTRAKKER M720E52WT	
I-380E34.15	41025132 41296801	Anillo reten  Ø188/Ø192 x Ø191/ Ø195 x 15	EUROTRAKKER EUROTRAKKER CURSOR AD TRAKKER AT TRAKKER	
I-380E34.06/1	41016627	Arandela cierre	AD TRAKKER AT TRAKKER EUROTRAKKER CURSOR EUROTRAKKER	
I-380E34.05	41016555	Freno tapa silleta	AD TRAKKER AT TRAKKER EUROTRAKKER CURSOR EUROTRAKKER	
I-330.30.20	2521861	Arandela de ataque 0.5mm	EUROTRAKKER 260-23 260-25 300-34 300-32	
I-330.30.21	2521862	Arandela de ataque 0,2mm	300-34 330-30 330-32	

Ref. Salanguera	Ref. Or.	Descripción	Modelo	
I-330.30.01	42032028 8138534	Silleta balancín  Ø160/Ø172 X 245	EUROTRAKKER 330-30 330-30N-NW	
I-330.30.16	1166134	Torica reten	EUROTRAKKER 330-30 330-30N-NW	
I-330.30.07	1172083	Tornillo  M16 x 70mm	EUROTRAKKER 330-30 330-30N-NW	
I-330.30.17	2521857	Arandela de cierre  Ø21 x Ø125 x 20	EUROTRAKKER 330-30 330-30N-NW 330E34 330E37	
I-330.30.03	42016750 42001244	Rodamiento exterior Ø103 x Ø160 x 39	EUROTRAKKER 330-30 330-30N-NW	
I-330.30.11	42032068	Tapa de silleta  M18x1,5 x Ø170 x 60	EUROTRAKKER 330-30 330-30N-NW 330E34 330E37	
I-330.30.02	42043068	Rodamiento interior  Ø105 x Ø160 x 58,5	EUROTRAKKER 260-23 260-25 300-34 300-32 300-34 330-30 330-32	

Ref. Salanguera	Ref. Or.	Descripción	Modelo	
I-330.30.05	42043079	RETEN	EUROTRAKKER 260-23 260-25 300-34 300-32 300-34 330-30 330-32	
I-330.30.19	42050613	Junta tórica  Ø170 X 5mm.	EUROTRAKKER 260-23 260-25 300-34 300-32 300-34 330-30 330-32	
I-330.30.04	42051001	Pista porta retén	EUROTRAKKER 260-23 260-25 300-34 300-32 300-34 330-30 330-32	
I-330.30.12	42051017	Freno tapa silleta	EUROTRAKKER 260-23 260-25 300-34 300-32 300-34 330-30 330-32	
SB-8120	42052764	Placa separación: Ø84 Tetón 24mm.	EUROTECH EUROSTAR TURBOTECH TURBOSTAR EUROTECH CNG	
SB-8120/1		Placa separación: Ø70 Tetón 20mm.	EUROTECH CURSOR EUROSTAR CURSOR AD STRALIS AT STRALIS	
SB-8120/2	98405404	M12/175 x 80 x 80 x26 Ballesta de 80mm	EUROCARGO TECTOR TECTOR RESTYL E.FIRE RESTYL EUROFIRE	
SB-8120/3	98401286	M8/125 x 66 x 80 x 24 Ballesta de 70mm	EUROFIRE TECTOR EUROTECH	
SB-317892	42557588	Silent-bloc suspensión neumática trasera  31,5 x 78 x 62,5 x 92	EUROCARGO	





Ref. Salanguera	Ref. Or.	Descripción	Modelo	
SB-164043	99469085	16 x 40 x 43	29L10 29L12 29L14 35S10 35S11 35S12 35S13 35S14	
SB-164035	93808935	16 x 40 x 35	EUROCARGO TECTOR	
SB-164040	08587681	16 x 40 x 40	EUROFIRE TECTOR EUROFIRE ZETA	
SB-164540	98482540	16 x 45 x 40	DAILY CNG TURBODAILY 4X4 DAILY 35C9/10/11/12/13/14/15/17	
SB-70640 KIT	504112265 504054600	Kit silent-bloc, casquillo  Silent-bloc: Ø24 x Ø42 x 32  Casquillo: Ø16 x 24 x 87	DAILY	
SB-8129 KIT	504112266 504048721	Kit silent-bloc, casquillo  Silent-bloc: Ø24 x Ø41 x 33  Casquillo: Ø16 x 24 x 70	35 c10 35 C11 35 C12 35 C13 35 C14	
SB-8130 KIT	504011462 504089477	Kit silent-bloc, casquillo  Silent-bloc: Ø28 x Ø48 x 37,5  Casquillo: Ø16 x 28 x 80	TECTOR PROWAY EUROCARGO EUROFIRE	
SB-8122	98413939	Silent-bloc ballesta Ballesta: 80mm.  Ø20 x 57 x 70 x 84	EUROCARGO TECTOR TECTOR RESTYL EUROFIRE RESTYL EUROFIRE TECTOR EUROTECH	
SB-8123	98413847	Silent-bloc ballesta Ballesta: 70mm.  Ø16 x 47 x 60 x 74	EUROCARGO TOECTOR EUROFIRE TECTOR EUROFIRE	









Ref. Salanguera	Ref. Or.	Descripción	Modelo	
SB-8126	8160686 2997221	Silent-bloc ballesta Ballesta: 90mm.  Ø20 x 62 x 86 x 97	EUROTRAKE CURSOR EUROTRAKKER EUROTECH EUROSTAR AD TRAKKER AT TRAKKER EUROTECH CURSOR EUROTECH CNG	
SB-8127	8160687	Silent-bloc ballesta Ballesta: 100mm.  Ø20 x 62 x 96 x 107	EUROTRAKKER EUROTECH AD TRAKKER AT TRAKKER EUROTECH CURSOR EUROMOVER EUROSTAR AD STRALIS AT ESTRALIS	
SB-8133	500356747	Silent-bloc ballesta  Ø20 x 57,5 x 80	EUROCARGO 120 EL15 120 EL21 TECTOR 120 E17 120 E21 120 E22	
SB-8132	7144310	Silent-bloc ballesta  Ø20 x 62 x 91		
SB-8128	Ballesta de 90mm.	Silent-bloc con bulón: Ø37 x 62 x 89 x 220	EUROTRAKKER EUROTRAKKER CURSOR AD TRAKKER AT TRAKKER AD TRAKKER E.E.	
SB-8128/1	Ballesta de 10mm.	Ø37 x 62 x 96 x 177		
SB-37642832	8162280	Silent-bloc gemela: Ø37 x 65 x 32,5	EUROTRAKKER EUROTRAKKER CURSOR AD TRAKKER AT TRAKKER AD TRAKKER E.E.	
SB-0810	500340498	Almohadilla punta Ballesta transversal.  Ballesta de 80mm.	IVECO	

Ref. Salanguera	Ref. Or.	Descripción	Modelo	
SB-8135	41033244	Placa separación: 65 x 75 x 12,3	EUROSTAR 240 E38, 240 E42, 240 E47 240 E 52, 260 E47, 400 E47 440 E38, 440 E42, 440 E47 440 E52	
SB-8121/3	41034160	80 x 100 x 12,5	EUROTECH 240 E25, 240 E38, 240 E42 440 E34, 440 E42	
SB-8134	41033487	Placa separación: 65 x 75 x 19	EUROSTRAR 240 E38, 240 E42, 240 E47 240 E52, 360 E47, 400 E47 440 E38, 440 E42, 440 E47 440 E5 EUROTECH 240 E25, 240 E38, 240 E42 400 E34, 400 E42, 440 E34 440 E38, 440 E42	
SB-8121/4	41032459	Placa separación: 80 x 100 x 12,5/17,5	EUROSTAR 190E 38..52, 240 E38...52 360 E42/47/52, 440 E38...52 EUROTECH 190 E34/38/42, 240 E25...38 240 E42, 260 E38/42 400 E34/42, 440 E34/38/42 AS STRALIS E4 440 S42...56	
SB-8121	8138611	Tope ballesta: M10 x 100 x 80 x 25	EUROSTAR 190 E42, 190 E47, 190 E52 400 E42, 400 E52, 440 E38 440 E42, 440 E47, 440 E52 EUROTECH 180 E34, 180 E38, 180 E42 190 E34, 190 E38, 190 E42 400 E34, 400 E38, 400 E42 440 E34, 440 E38, 440 E42	
SB-8121/1	41006350	Tope ballesta: 100 x 88 x 27,5	EUROTRAKKER CURSOR EUROTRAKKER EUROTECH AD TRAKKER AT TRAKKER EUROTECH CURSOR EUROMOVER EUROSTAR AD STRALIS	
24.16.0096	4601722 4733199	Silent-bloc barra Estabilizadora  Ø28 x 60 x 50	EUROCARGO TECTOR TECTOR RESTYL EUROFIRE TURBOTECH TURBOSTAR EUROTECH	
24.16.0053	8162306	Silent-bloc barra Estabilizadora  Ø28 x 63 x 50	TECTOR TECTOR RESTYL EUROCARGO EUROFIRE EUROTRAKKER CURSOR EUROTECH STRALIS	

Ref. Salanguera	Ref. Or.	Descripción	Modelo	
24.16.0054	500336108 8162306 41218902 41288750	Silent-bloc barra Estabilizadora  Ø28 x 62 x 50	EUROTECH CURSOR EUROSTAR CURSOR AD STRALIS AT STRALIS AS STRALIS EUROTECH STRALIS	
24.16.0088	4791448 4606379	Silent-bloc barra Estabilizadora  Ø20 x 46 x 55	TECTOR TECTOR RESTYL. EUROCARGO EUROTECH	
24.16.0055	4606624	Silent-bloc barra Estabilizadora  Ø20 x 46 x 42	EUROCARGO TECTOR	
24.16.0057	8557842	Silent-bloc barra Estabilizadora  Ø16 x 40 x 43	A70-14 ZETA A90-14 ZETA	
24.16.0097	98486768	Silent-bloc barra Estabilizadora  Ø20 x 48,5 x 55	TECTOR EUROFIRE EUROCARGO	
24.16.0059	41218902 41288750	Silent-bloc barra Estabilizadora  Ø28 x 62 x 50	AD TRAKKER AT TRAKKER EUROTRAKKER CURSOR MIDIRINER	
24.16.0056	8127423	Silent-bloc barra Estabilizadora  Ø33 x 42 x 27	EUROCARGO TECTOR TECTOR RESTYLING EUROFIRE TECTOR PROWAY PROXYS	

Ref. Salanguera	Ref. Or.	Descripción	Modelo	
24.16.0063	4792127	Ø40 x 58	EUROCARGO TECTOR RESTYLING	
24.16.0064	8125528	Ø35 x 58	115-17 130 E17 140 E18 A175-24	
24.16.0065	98415468	Ø42 x 68		
24.16.0066	8127910	Ø36,5 x 58	EUROCARGO TECTOR	
24.16.0067	8125527	Ø32 x 58	EUROFIRE PROWAY PROXY	
24.16.0068	98431946	Ø46 x 68		
24.16.0069	98415469	Ø42 x 68	TURBOSTAR EUROCARGO	
24.16.0070	4731981	Ø44 x 60 x 70	TECTOR TURBOTECH	
24.16.0071	4740646	Ø59 x 81		
24.16.0072	98407169	Ø42 x 66	EUROCARGO TECTOR	
24.16.0073	4735723	Ø51,5 x 78	TURBOSTAR TURBOTECH	
24.16.0074	98407168	Ø44,5 x 66		
24.16.0075	4796746	Ø42 x 66	115-14 115-17	
24.16.0076	4796971	Ø38 x 66	135-17 A135-14 A135-17	
24.16.0077	4688153	Ø49 x 84	A135-24 TURBOTECH TURBOSTAR AP-160	
24.16.0078	4754678	Ø48 x 70	EUROTECH CURSOR EUROSTAR CURSOR	
24.16.0079	99482437	Ø50,5 x 74	AS STRALIS AD STRALIS AT STRALIS	
24.16.0080	98488528	Ø40 x 60	STRALIS EUROCARGO TECTOR EUROFIRE	
24.16.0081	4849258	Ø35 x 60	TECTOR EUROCARGO	
24.16.0082	98488743	Ø44 x 60	EUROFIRE EUROFIRE TECTOR	
24.16.0083	98451947	Ø42 x 60		

Ref. Salanguera	Ref. Or.	Descripción	Modelo	
24.16.0115	8557780	Ø24 x 39,5	50-9 ZETA M.Y. 2006	
24.16.0113	8560291	Ø35 x 55 x 51	65 C14, 65 C15, 65 C18 70 C15, 70 C17, 70 C14	
24.16.0114	8581295	Ø26 x 60	ZETA TURBOZETA	
24.16.0084	8127383	Ø40 x Ø54,5 x 62	EUROCARGO TECTOR	
24.16.0085	8125492	Ø34 x Ø54,4 x 62	EUROFIRE EUROFIRE TECTRO	
24.16.0086	93814618	Ø28 x Ø46 x 62	TURBODAILY DAILY CNG 65 C11/C13/C14/C15/C17	
24.16.0087	8125491	Ø32 x Ø54,5 x 62	EUROCARGO TECTRO	
24.16.0111	8125490	Ø30 x Ø54,5 x 62	EUROFIRE 60 E14, 65 E12, 65 E14 75 E12, 75 E14, 75 E15	
24.16.0089	4848464	Ø27 x Ø54,5 x 62		
24.16.0090	93814617	Ø26 x Ø46 x 62	TURBODAILY TURBODALILT (96)	
24.16.0091	8127381	Ø36 x Ø54,5 x 62	65 C11/C13/C14/C15/C17 DAILY CNG	
24.16.0092	93817504 93817505	Ø36 x Ø46 x 62	EUROCARGO TECTOR NEW DAILY	
24.16.0112	93814505	Ø24 x Ø46/57 x 62	35 S17W, 35 S18W 55 S15W, 55 S17W	
24.16.0093	93819387	Ø32 x Ø46 x 62	TURBODAILY 65 C13	
24.16.0116	4739171	Ø53 x Ø65 x 60	TURBOTECH	
24.16.0094	8585819	Ø36 x Ø48 x 35	DAILY CNG TURBODAILY 40. 10WM...15WM 65 C11...21 70 C14...21	







Ref. Salanguera	Ref. Or.	Descripción	Modelo	
24.16.0095	93802248	Ø20 x Ø48 x 35	DAILY 35-10, 35-8, 45-10 A 45-10 TURBODAILY 30-10, 35-12, 49-12 A 45-12 35 C8...21, 40 C10...21 50 C11...21	
24.16.0051	2521481	Ø54 x Ø93,5 x 70/80	EUROTRAKKER EUROTECH EUROMOVER EUROSTAR AD TRAKKER AT TRAKKER STRALIS EUROTECH CURSOR EUROTRAKER CURSOR	
24.16.0058	2520448	Ø40 x Ø74 x 70/80		
24.16.0098	8189831	Ø45 x Ø74 x 70/80		
24.16.0099	2521850	Ø50 x Ø95 x 70/80	EUROSTAR EUROTECH EUROTECH CURSOR EUROSTAR CURSOR TRAKKER AD STRALIS AT STRALIS EUROCARGO 150 E15H, 150 E23H 180 E30	
24.16.0100	98469635 / 8509450	Ø48 x Ø74 x 70		
24.16.0101	98469634 / 8509460	Ø46 x Ø74 x 70		
24.16.0061	8169892 / 41270883	Ø62 x Ø96,5 x 70/80	EUROSTAR EUROCARGO EUROTECH EUROTRAKKER STRALIS TECTOR	
24.16.0103	7516801 / 098456259	Ø46 x Ø95 x 70/80		
24.16.0104	2521482 / 0281007	Ø45 x Ø95 x 70/80		
24.16.0105	98444833 / 8509220	Ø63 x Ø95 x 70/80	EUROCARGO EUROTECH TECHTOR 180 E21/24/28	
24.16.0106	98444831 / 8508760	Ø58 x Ø95 x 70		
24.16.0107	98444832	Ø62 x Ø92 x 70/80		
24.16.0108	98470579	Ø48 x Ø95 x 70/80	EUROTECH EUROSTAR STRALIS TRAKKER 120-13ANW / 17ANW 130-13AN, 160-17AN-ANW 190-25AN / 26H / 26N-NW	
24.16.0109	2532404	Ø35 x Ø73 x 70/80		
24.16.0110	41015581	Ø66 x Ø92 x 60/65		
24.16.0117	42120135	Bulón tirante barra Ø28 x 90 c/t	EUROTRAKKER EUROTECH EUROMOVER EUROSTAR AD TRAKKER AT TRAKKER STRALIS EUROTECH CURSOR EUROTRAKER CURSOR	

Ref. Salanguera	Ref. Or.	Descripción	Modelo	
SOPIV-0001		Soporte ballestín		
NISSAN-00015/1		Tope goma 2 Tornillos		
SOPIV-0003		Soporte ballestín	ECO T-100	
SOPIV-0004		Soporte ballestín IVECO 190		
IVECO-0002		Soporte ballestín Ballesta de 80mm.	EUROTECH	
IVECO-0001		Soporte ballestín Ballesta de 70mm.	EUROTECH	
SOPIV-0005		Soporte ballestín	ECO T 100	
SOPIV-0006		Kit soportes ballestín	IVECO 35 C-11	

Ref. Salanguera	Ref. Or.	Descripción	Modelo	
SOPIV-0007	4203706	Soporte resbalón IVECO 260.26	IVECO 260.26	
SOPIV-0008	8164042	Soporte resbalón Delantero Izquierdo Trasero Derecho	EUROSTAR EUROTRAKKER EUROTECH TRAKKER	
SOPIV-0010	8160830	Soporte resbalón Delantero Derecho Trasero Izquierdo	EUROSTAR EUROTRAKKER EUROTECH TRAKKER	
ALIV-0001	42052391	Almohadilla asiento abarcón	EUROSTAR EUROTECH EUROTECH CURSOR EUROTRAKKER CURSOR EUROTRAKKER STRALIS	
SOPIV-0011	8161687	Soporte ballesta Trasero ballesta trasera	TRAKKER	
SOPIV-0012	8138880	Soporte ballesta Soporte delantero Ballesta trasera	EUROTRAKKER EUROSTAR STRALIS	
SOPIV-0013	8138188	Soporte derecho barra estabilizadora	EUROSTAR EUROTECH EUROTRAKKER EUROTECH CURSOR EUROTRAKKER CURSOR AD STRALIS AT ESTRALIS	



Ref. Salanguera	Ref. Or.	Descripción	Modelo	
SOPIV-0014	8138187	Soporte izquierdo barra estabilizadora	EUROTECH EUROTRAKKER EUROTECH CURSOR EUROTRAKKER CURSOR AD STRALIS AT ESTRALIS	
SEMIVE-0001	8134539	Kit de Semi-gemelas 90 x 25 x 10 x Ø/Ø: 115		
SB-37884AR	8138938	Arandela de acero Lisa Ballesta de 90mm.  Ø37 x Ø88 x 4	EUROTRAKE CURSOR EUROTRAKKER EUROTECH EUROSTAR AD TRAKKER AT TRAKKER EUROTECH CURSOR EUROTECH CNG	
SB-20774AR	98465949	Arandela de acero Escalonada Ballesta de 80mm.  Ø20 x Ø77 x 4	EUROCARGO TECTOR TECTOR RESTYL EUROFIRE RESTYL EUROFIRE TECTOR EUROTECH	
13.06.0057	41218620 41218621	Tirante en V  L: 665mm. Tubo de: Ø48  Kit puntas: 13.06.0058 Kit central: 100706003	STRALIS STRALIS 2007 TRAKKER AD	
100706003	42567359  MERCEDES: 0003504805 0003503305  MAN: 81432706101 81432706109 81432706139	Kit reparación central:  Bola: Ø85mm Taladro: Ø25mm Distancia Ø/Ø: 152mm Ancho: 24mm	STRALIS STRALIS 2007 TRAKKER AD	
13.06.0058	42567360	Kit reparación puntas:  Bola: Ø75mm Taladro: Ø21mm Distancia Ø/Ø: 130mm	STRALIS STRALIS 2007 TRAKKER AD	

Ref. Salanguera	Ref. Or.	Descripción	Modelo	
13.06.0050	4716271	Tirante en V L: 668mm. / 657mm. Tubo de: Ø50 Kit puntas: 13.06.0051 Kit central: 13.06.0052	TURBOSTAR 190-36/42/48 TURBOTECH 190-32, 190-36 220-32, 220-36 240-36 GV TURBOTECH 190-32, 190-36	
13.06.0051	2980884	Kit reparación puntas:  Bola: Ø72mm Taladro: Ø19mm Distancia Ø/Ø: 130mm Ancho: 30mm	TURBOSTAR 190-36/42/48 TURBOTECH 190-32, 190-36 220-32, 220-36 240-36 GV TURBOTECH 190-32, 190-36	
13.06.0052	2968454	Kit reparación central:  Bola: Ø72mm Cono: Ø38mm Largo: 46mm	TURBOSTAR 190-36/42/48 TURBOTECH 190-32, 190-36 220-32, 220-36 240-36 GV TURBOTECH 190-32, 190-36	
13.06.0053	41002770 41009665 41028598 41028600 41034479 41042050 8138026	Tirante en V L: 665mm. Tubo de: Ø46  Kit puntas: 13.06.0054 Kit central: 13.06.0055	EUROTECH EUROSTAR EUROMOVER EUROTRAKKER CURSOR EUROSTAR CURSOR EUROSTAR CURSOR STRALIS TRAKKER	
13.06.0054	93161960 1252284 274070	Kit reparación puntas:  Bola: Ø75mm Taladro: Ø21mm Distancia Ø/Ø: 130mm Ancho: 21mm	EUROTECH EUROSTAR EUROMOVER EUROTRAKKER CURSOR EUROSTAR CURSOR EUROSTAR CURSOR STRALIS TRAKKER	
13.06.0055	93161958 1376730 3093469	Kit reparación central:  Bola: Ø72mm Cono: Ø38mm Largo: 46mm	EUROTECH EUROSTAR EUROMOVER EUROTRAKKER CURSOR EUROSTAR CURSOR EUROSTAR CURSOR STRALIS TRAKKER	
13.06.0056	41028599 41042092 504064007 98472468 98405832	Tirante en V L: 659mm. Tubo de: Ø46  Kit puntas: 13.06.0054 Kit central: 13.06.0055	TECTOR 130 E18, 130 E24, 150 E18 150 E24, 150 E28, 320 E28T TECTOR RESTYL. 130 E18, 130 E21, 130 E24 130 E28, 140 E18, 140 E21 140 E24, 140 E28, 150 E221 150 E24, 150 E28, 160 E21 160 E24, 160 E28	

## EUROTRAKKER 260T38 AT



FIGURA	O.R.	CANTIDAD	DESCRIPCIÓN	R. SALANGUERA
4	41009760	1	Semieje Ø88-Ø98	100504003
7	41009826	1	Rodamiento interior Ø	100504011
8	8137491	1	Silleta balancín	100504001
11-12	42040761	1	Rodamiento exterior Ø	100504009
15	42072130	2	Arandela reglaje 0,2mm.	100504014
16	42072129	2	Arandela reglaje 0,5mm.	100504013
17	42072128	2	Arandela reglaje 1,0mm.	100504012
18	41032181	2	Arandela reglaje 3,0mm	100504015
19	8138585	1	Arandela amarre	100504005
20	1164572	4	Tornillos fijación M14 x 70	100504016
21	42017473	1	Tapa silleta balancín	100504006
22	42051190	1	Freno tapa silleta	100504007
23	42050612	1	Junta tórica tapa silleta	100504017
27	41042011	1	Reten	100504002
25	17297380	1	Tórica eje 98mm	100504019
26	41042012	1	Arandela	
14	1110425	1	Anillo cobre junta tapón Ø18x24	100504018
13	1118718	1	Tapón roscado M18x1.5	100504008

## EUROTRAKKER 330.30 E 34

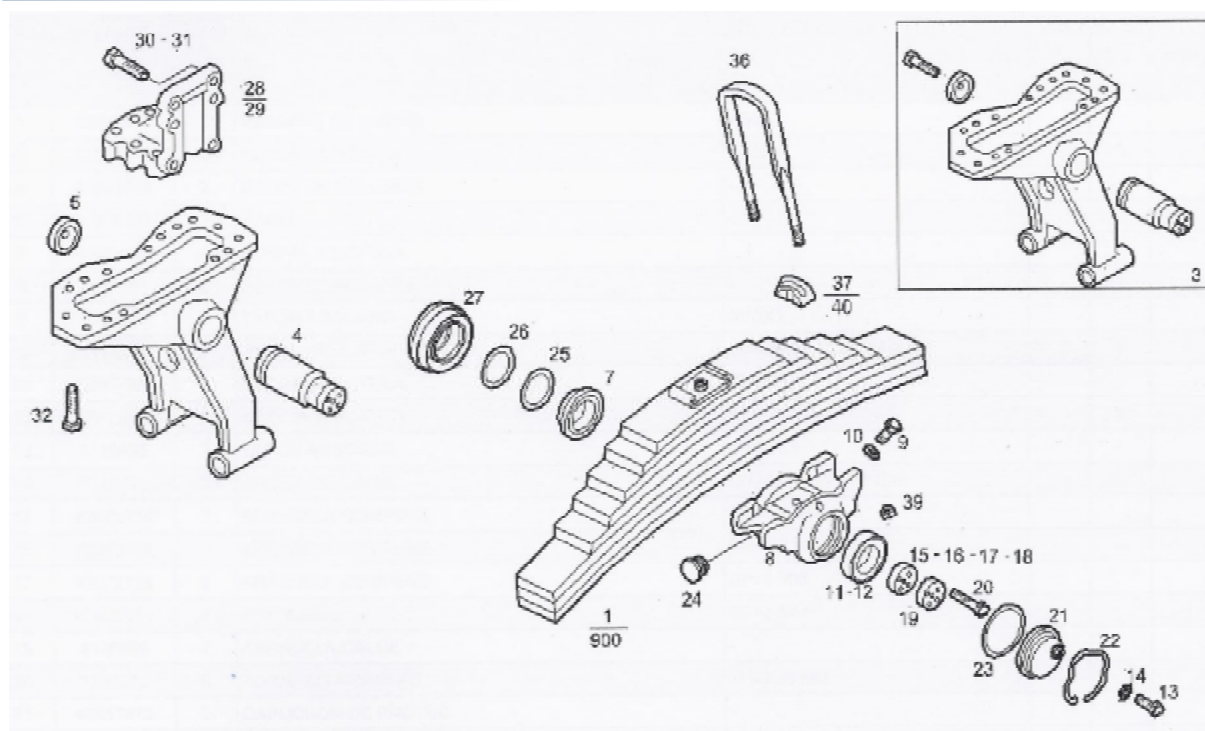

FIGURA	O.R.	CANTIDAD	DESCRIPCIÓN	R. SALANGUERA
6	1133134	1	Torica porta reten	I-330.30.16
7	1172083	1	Tornillo amarre M16 x 70mm.	I-330.30.07
12/36	42001244	2	Rodamiento exterior	I-330.30.02
15	42032028	2	Silleta balancín	I-330.30.01
16	42032068	2	Tapa silleta	I-330.30.11
19	42043068	2	Rodamiento interior	I-330.30.03
20	42043079	2	Reten	I-330.30.05
23	42050613	2	Junta torica	I-330.30.19
24	42051001	2	Pista reten	I-330.30.04
25	42051017	2	Freno tapa silleta	I-330.30.12
33	2521861	2	Suplemento 0,5 mm.	I-330.30.20
34	2521862	2	Suplemento 0.2 mm.	I-330.30.21
8	2521857	1	Arandela de cierre	I-330.30.17

## EUROTRAKKER 380T38 AT/AD

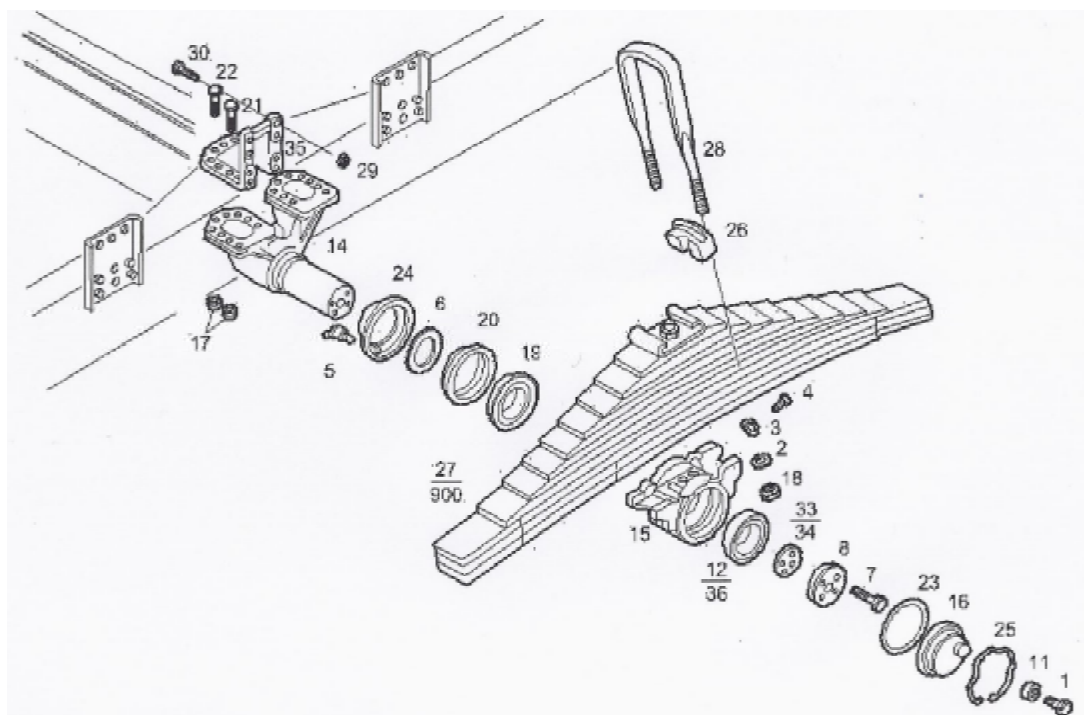

FIGURA	O.R.	CANTIDAD	DESCRIPCIÓN	R. SALANGUERA
4	8138275	1	Semieje Ø120-Ø122	I-380E34.03
75	8138307	1	Rodamiento interior	I-380E34.07
76	8138566	1	Silleta balancín	I-380E34.01
77	8138308	1	Rodamiento exterior	I-380E34.08
78	8138507	1	Arandela reglaje 0,2mm.	I-380E34.11
79	8138508	1	Arandela reglaje 0,5mm.	I-380E34.10
80	8138509	1	Arandela reglaje 1,0mm.	I-380E34.09
81	8138327	1	Tapa silleta	I-380E34.04
82	17299681	1	Junta tapa silleta 367mm x 5,33	I-380E34.13
83	17298081	1	Junta torica	I-380E34.12
84	40101540	1	Reten	I-380E34.02
85	41025132	1	Anillo	I-380E34.15
88	41016627	1	Arandela cierre	I-380E34.06/1
89	41016555	1	Freno tapa silleta	I-380E34.05

MAN

Ref. Salanguera	Ref. Or.	Descripción	Modelo	
BB-4090	81413060090	Bulón ballesta	M 90 12.192	
	81413060070	Eje delantero	M 90 12.222	
	81413060087		M 90 12.232	
		Ø25 x 130	M 90 12.272 M 90 24.232 M 90 24.262	
BB-4091	81413060084	Bulón ballesta	14.../15...	
	81413060071	Eje delantero	16...	
	81413060067		19...	
	81413060080	Ø25 x 143	26.../32...	
	81413060055			
BB-4092	81413060089	Bulón ballesta	F 90 24.242	
		Eje delantero	F 90 24.262	
			F 90 24.272	
		Ø30 x 146	F 90 24.362	
			F 90 24.372	
			F 90 24.424 F 90 24.422	
BB-4093	81413060085	Bulón ballesta	F 90 19.262	
	81413060078	Eje delantero	F 90 19.272	
	81413060032		F 90 19.292	
	81413060074	Ø30 x 162	F 90 19.322	
	81413060001		F 90 19.342	
			F 90 19.362 F 90 19.372 F 90 19.402 F 90 19.422	
BB-4094	81413060082	Bulón ballesta	M 90 12.152	
	81413060075	Eje delantero	M 90 12.192	
	81413060062		M 90 12.222	
		Ø30 x 126	M 90 12.232	
			M 90 12.262	
			M 90 12.272	
			M 90 14.152 M 90 17.192 M 90 18.222	
BB-4095	81413060095	Bulón ballesta	E 2000 30.360	
		Eje delantero	E 2000 30.410	
			E 2000 30.460	
		Ø30 x 142	E 2000 32.410	
			E 2000 32.460	
			E 2000 33.410	
			E 2000 35.460	
			F 90 19.242	
			F 90 41 402	
CAPUCHINOS:	CP-30121170	30 x 12 x 170	DELANTEROS	
	CP-30121190	30 x 12 x 190		

Ref. Salanguera	Ref. Or.	Descripción	Modelo	
CAPUCHINOS:	CP-3514260	35 x 14 x 260	TRASEROS	
	CP-3514280	35 x 14 x 280		
	CP-3514300	35 x 14 x 300		
CAPUCHINOS:	CP-121002024	12 x 100	Diámetro: Ø12	
	CP-121202024	12 x 120	Ancho cabeza: Ø20	
	CP-121402024	12 x 140	Altura cabeza: 24mm.	
	CP-121602024	12 x 160		
CB-253080	81413040043	Casquillo ballesta Ø25 x Ø30 x 80	M 90	
	81413040008		SERIES E	
	81434200014		12... 14... 16... 17...	
CB-253090	81413040042	Casquillo ballesta Ø25 x Ø30 x 90	F 2000 19.233	
	81434200000		F 2000 19.273 F 2000 19.293 F 90 19.332 F 90 19.372	
CB-3036100	81413040040	Casquillo ballesta Ø30 x Ø36 x 100	F 90	
	81413040038		M 90	
	81434200012		G 90 SERIES E F 90	
SB-8050/5	81962100402	Placa punta ballesta M12/150 84,5 x 74,5 x 41	19.422 L 2000 G 90	
SB-8050/4	81962100379	Placa chasis Dumper	TGA TGA TGX TGM F90, L/F2000	

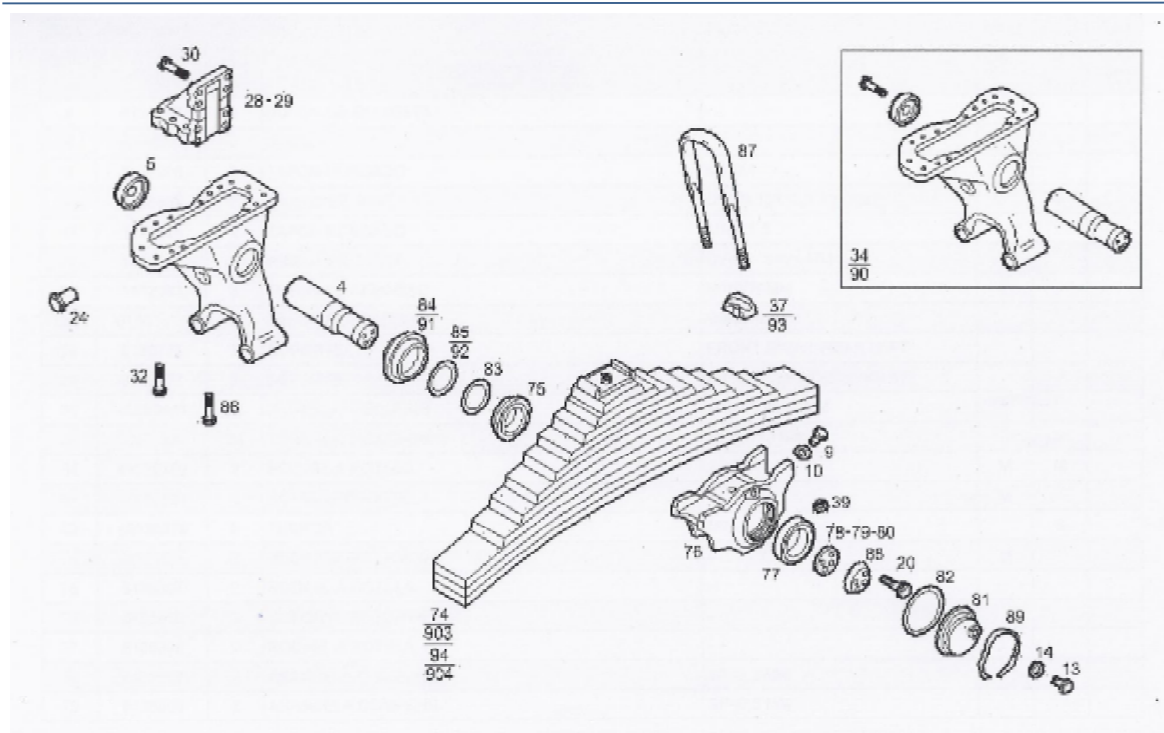

Ref. Salanguera	Ref. Or.	Descripción	Modelo	
SB-8051	81961010739 81961010690	Placa separación: Ø70 x 12 Tetón 20mm.	M 90 G 90 L 2000 M 2000 L M 2000 M	
SB-8051/2		Ø60 x 10 Tornillo 12mm.		
SB-8051/1	81434006484 83960200506	Placa separación: 80 x 105 x 15	SERIES E F 2000 F 90	
SB-8051/3	81434070109 83434070509 81434075003  MERCEDS-BENZ: 9433235384	Placa separación: 84 x 110 x 15	TGA TGS TGX TGL TGM ECT F 90 F 2000 SEIRES E	
SB-8053	81960200250 81960200231 81960200252  VOLVO: 6879332	Silent bloc ballesta Ø16 x 50 x 95	TGA TGM TGS G / G90 M 90 L 2000 M 2000 L M 2000 M	
SB-8058	81437220044 81437220061	Silent bloc ballesta Ø24,2 x 70 x 88 x 95	E 2000 19.310 E 2000 19.360 E 2000 19.410 E 2000 19.460 F 2000 18.273 F 2000 19.233 F 2000 19.273 F 2000 37.464 F 2000 41.423	
SB-8059	81437220045 81437220062	Silent bloc ballesta Ø24,2 x 70 x 88 x 105	SERIES E SERIES F	
SB-185786	81962100557 85437220009	Silent bloc ballesta Ø18 x 57 x 86	TGA TGL	

Ref. Salanguera	Ref. Or.	Descripción	Modelo	
SB-205784	81437220051	Silent bloc ballesta	ECM	
	81437220078	Ø20 x 57 x 84	L 2000	
	81437220079		M 2000 L M 2000 M	
SB-206295	81437220092	Silent bloc ballesta Ø20 x 62 x 95	TGL TGM	
SB-8059/1	81437220070	Silent bloc ballesta	TGS	
	81962100616	Ø24 x 65 x 88 x 95	TGX TGA F 2000 ECT 18/26	
SB-8059/2	81437220087	Silent bloc ballesta	TGS	
	81962100634	Ø24 x 65 x 100	TGX TGA F 2000	
SB-246295	81437220091	Silent bloc ballesta Ø24 x 62 x 95	TGS TGX TGA ECT 25.... 26....	
SB-186186	85437220008	Silent bloc ballesta	TGL	
	85437220010	Ø18 x 61 x 86		
SB-246495	81437220070 S	Silent bloc ballesta	TGS	
	81962100616 S	Ø24 x 64 x 95	TGX TGA ECT F 2000 18.... 25.... 26.... 32....	

Ref. Salanguera	Ref. Or.	Descripción	Modelo	
SB-8052	81962105021 81962105022 81962105023	Tope suspensión h: 127	SERIES E F 90 F 2000 M 2000 L 26....	
SB-8052/1	81962100554 81962100547	Tope suspensión Derecho h: 133	TGS TGX TGA TGM F 2000 25.... 26.... 32.... 44....	
SB-8052/2	81962100555 81962100548	Tope suspensión Izquierdo h: 133	GX TGA TGM F 2000 25.... 26.... 32.... 44....	
SB-8052/3	81962105025 81962105026 81962105027	Tope suspensión h: 166	SERIES E F 2000	
SB-8052/4	81962100550	Tope suspensión h: 154	TGA F 2000	
SB-8050	81434070102	Placa separación 140 x 100 x 18	SERIES E F 2000 19....	
SB-8050/1	81434070112	Placa separación 120 x 80 x 18	TGS TGA TGM F 2000 M 2000 L M 2000 M 13..../ 14.... 18....	

Ref. Salanguera	Ref. Or.	Descripción	Modelo	
SB-8050/2	81961010695 96200323 9066422	Taco ballesta M10x120 x 85 x 19	F 90 F 2000 SERIES E M 2000 L	
SB-8050/6	81962100431 81962100532	Taco ballesta M8/125 x 43 x 19	M 90 L 2000 M 2000 L M 2000 M 11.../12.... 13.../14....	
SB-8135	85434070004  IVECO: 41033244	Placa separación: 65 x 75 x 12,3	TGL TGM	
SB-8060/9	85434070003  MERCEDES: 6753250184 6753250284 9703250084 9703250184	Placa separación: 70 x 90 x 18,5	TGL TGM	
TA-20200210 ST	06014934930	Tornillo M20/200 x 210	TGA CLA F 2000 SERIES E TGM TGS	
TA-20200230 ST	06014946932	Tornillo M20/200 x 230		
TA-20200240 ST	06014990218	Tornillo M20/200 x 240		
TA-20200260 ST	06014944935	Tornillo M20/200 x 260		
TA-20200280 ST	06014934937	Tornillo M20/200 x 280		
24.16.0168	81437220022 81962100469 81437220038	Silent bloc barra Estabilizadora Ø16 x 45 x 47	TGA / TGS / TGX / TGL TGM / ECM / ECT ND / NG / NMT / NL / SL / SG SUE / UEL 19.372 / 19.433 22.360 33.372	
24.16.0150	81910200618	Bulón barra estb. M16/150*Ø22*75*100	TGA / TGM TGS / TGX ECM / ECT CLA / M 90 SERIES E F 90 / F 2000	

Ref. Salanguera	Ref. Or.	Descripción	Modelo	
24.16.0169	85437220007	Silent bloc barra estabilizadora Ø14 x 42,5 x 35	TGM TGL	
24.16.0163	81432710029 81432710008	Silent bloc barra estabilizadora Ø16 x 45 x 42	M 90 SERIES E 14.../15... 16.../17... 18.../19... 22.../24.../25.../26... 32.../33.../34...	
24.16.0170	81432710022 81432710011 81432710021	Silent bloc barra estabilizadora Ø18 x 55 x 55		
24.16.0165	81437220019 81437226051	Silent bloc barra estabilizadora Ø22 x 75 x 62	TGA F 90 F 2000 SERIES E 19.422 22... / 24... / 25... / 26...	
24.16.0166	1437220021	Silent bloc barra estabilizadora Ø22 x 65 x 62	M 90 F 2000 SERIES E 19.422 22... / 24... / 25... / 26...	
24.16.0164	81962100450 81437220038 81962100469	Silent bloc barra estabilizadora Ø16 x 47,5 x 47	TGS / TGX / TGA TGL / TGM ND / NG / NMT NL / NUE SG / SL SUE / UEL / RH SERIES E	
24.16.0183	81437220059	Silent bloc barra estabilizadora Ø16 x 50 x 47	LION'S TGA TGS TGX TGL TGM ND / NG / NM NL / NUE / SL	

Ref. Salanguera	Ref. Or.	Descripción	Modelo	
24.16.0184	81437220039	Silent bloc barra estabilizadora Ø22 x 67,5 x 62	TGA / TGX F 90 / M 90 F 2000 SERIES E M 2000 L M 2000 M 19.422 / 19.423 33.423	
24.16.0167	81437220063 81437220082	Silent bloc barra estabilizadora Ø22 x 68 x 62	TGA / TGM TGS / TGX ECM / ECT CLA / M 90 SERIES E F 90 / F 2000 L 2000 M 2000 L M 2000 M	
24.16.0185	81437220047	Silent bloc barra estabilizadora Ø24 x 64 x 44	UEL / SUE NL / NG / ND SG / SL / ND SG / SL / EL NGT / NMT 12... / 14... 18... 24... 28...	
24.16.0151	81962100618	Silent bloc barra estabilizadora Ø18 x 48 x 40	TGX TGS TGA	
24.16.0186	81962100294	Silent bloc barra estabilizadora Ø12 x 33,5 x 32	G G 90 L 2000 M 2000 L 8... / 9... 10... 11... / 12... 15...	
24.16.0187	81960200286 81437040039 81942992220	Silent bloc barra estabilizadora Ø14 x 37,5 x 51	G / G 90 L 2000 M 2000 L M 2000 M 8... / 9... 10... 11... / 12... 15...	
24.16.0159	81437040025	Casquillo nilón barra estabilizadora Ø55 x 65 x 80	M 90 14... / 15... / 16... / 17... 18... / 19... / 22... / 24... 25... / 26... / 32... / 34...	

Ref. Salanguera	Ref. Or.	Descripción	Modelo	
24.16.0157	81437040026	Casquillo nilón barra estabilizadora Ø38 x 58 x 74	14... / 15... 16... / 17... 18... / 19... 22... / 24... / 25... / 26... 23... / 33... / 34...	
24.16.0158	81437040029	Casquillo nilón barra estabilizadora Ø45 x 55 x 80	SERIES E M 90 / G 90 L 2000 M 2000 L M 2000 M 10... 11... / 12... 13... / 14... / 15...	
24.16.0160	81437040032	Casquillo nilón barra estabilizadora Ø60x 70 x 81	F 90 14... / 15... / 16... 17... / 19... 22... / 24... / 25... 30... / 32... / 33... / 34...	
24.16.0161	81437040053	Silent bloc barra estabilizadora Ø35,5 x 56,5 x 51,5	8... / 9... L 2000 M 2000 L G / G 90	
24.16.0162	81437040052	Silent bloc barra estabilizadora Ø31,5 x 56,5 x 51,5	G G 90 L 2000	
24.16.0194	81437040038	Silent bloc barra estabilizadora Ø39 x 56,6 x 51,5	L 2000 M 2000 M G / G 90 8... / 9... / 10...	
24.16.0195	85437040002	Silent bloc barra estabilizadora Ø31 x 53 x 46	TGL 8 TGL 12	

Ref. Salanguera	Ref. Or.	Descripción	Modelo	
24.16.0196	85437040004	Silent bloc barra estabilizadora Ø39 x 53 x 46	TGL	
24.16.0181	81437220052	Silent bloc barra estabilizadora Ø34,5 x 55 x 60	L 2000 M 2000 L M 2000 M 10... 11... / 12... 13... / 14...	
24.16.0209	81437040094 81437040081	Silent bloc barra estabilizadora Ø35 x 55 x 51	TGS TGX TGA TGM	
24.16.1080	81437220053	Silent bloc barra estabilizadora Ø39 x 55 x 60	L 2000 L 2000 L M 2000 M 10... 11... / 12... 13... / 14...	
24.16.0197	81962100278	Silent bloc barra estabilizadora Ø27 x 50,5	G G 90 L 2000 M 2000 M 8... / 9... 10... / 11...	
24.16.0198	81437040005	Silent bloc barra estabilizadora Ø26 x 46 x 66	TGL	
24.16.0199	81437220040 81437220041 81437220042	Silent bloc barra estabilizadora Ø55 x 83 x 70	TGS / TGX / TGA TGL / TGM NMT F 2000 M 90 / F 90 DERIES E M 2000 L M 2000 M 12... / 14...	



Ref. Salanguera	Ref. Or.	Descripción	Modelo	
24.16.0200	81437040077	Silent bloc barra estabilizadora Ø50 x 75 x 51	LION'S CITY TGA / TGS / TGX TGL / TGM / ECT ND / NG / NL L 2000	
24.16.0201	81437040078	Silent bloc barra estabilizadora Ø45 x 75 x 51	LION'S TGS TGX TGA TGM RH ND / NM / UEL ECT F 2000	
24.16.0202	81437220083	Silent bloc barra estabilizadora Ø60 x 88 x 60	TGS TGX TGA TGM ECT F 2000 18...	
24.16.0203	81437220068 81437220069 81437220080	Silent bloc barra estabilizadora Ø50 x 84 x 72	TGS TGX TGA TGM F 2000 SERIES E M 2000 L	
24.16.0179	81437040074	Silent bloc barra estabilizadora Ø45 x 65 x 51	LION'S SERIE E CLA ECM M 2000 L M 2000 M F 2000 L 2000 11....	
24.16.0204	81437040079	Silent bloc barra estabilizadora Ø42 x 75 x 51	ECT TGA TGM TGS	
24.16.0152	81432710081	Silent bloc barra estabilizadora Ø54 x 93,5 x 70/80	F 90 F 2000 SERIES E F 90 UNTERFLUR 16... 18... 19... 22.../ 24... 26....	





Ref. Salanguera	Ref. Or.	Descripción	Modelo	
24.16.0172	81437040057	Silent bloc barra estabilizadora Ø44,5 x 67 x 60	LION'S SERIES E F 2000 F 90 M 90 M 2000 L	
24.16.0153	81437040060	Silent bloc barra estabilizadora Ø55 x 78 x 60	TGA ECM F 90 SERIES E M 2000 L M 2000 M F 90 UNTERFLUR 22... / 24... / 25... / 26... 14... / 18...	
24.16.0156	81437040061 81437220020	Silent bloc barra estabilizadora Ø60 x 78 x 60	TGS TGX TGA ECT F 90 F 2000 SERIES E M 2000 L M 2000 M	
24.16.0207	81962100609	Silent bloc barra estabilizadora Ø53,5 x 17/88	TGS TGX TGA ECT	
24.16.0208	81962100511	Silent bloc barra estabilizadora Ø47,5 x 21/101	TGM M 90 L 2000 M 2000 L M 2000 M 10... / 11... 10... / 12... 13... 16... / 17...	
24.16.0174	81432710080	Silent bloc barra estabilizadora Ø65,5 x 15/100	M 90 F 90 F 2000 SERIES E F90 UNTERFLUR 18... 19...	
24.16.0175	81432710082	Silent bloc barra estabilizadora Ø65,5 x 21/125	TGA CLA F 90 F 2000 SERIES E 14... / 15... 16... / 17... 26... / 27... / 32... / 33... / 34...	

Ref. Salanguera	Ref. Or.	Descripción	Modelo	
24.16.0176	81432710083 81432710079 81432710046	Silent bloc barra estabilizadora Ø75 x 21/125	F 90 SERIES E	
24.16.0177	81432710087	Silent bloc barra estabilizadora Ø65,5 x 19/130	16... 22.../ 24... SERIES E	
24.16.0205	81437220072	Silent bloc barra estabilizadora Ø68,5 x 15/100	TGS TGA F 2000 18...	
24.16.0206	81962100452	Silent bloc barra estabilizadora Ø47,5 x 19/99	M 90 M 2000 L M 2000 M 10.../11...	
24.16.0178	81432710078 81432710032	Silent bloc barra estabilizadora Ø75 x 19/130	14.../15... 16.../17... 16.../19... 22.../24.../25.../26... 30.../32.../33.../34...	
GEMA-0004	81413030079	Kit completo Ballesta delantera	TGA TGX TGS TGM ECT F 90 F 2000 SERIES E 18.../ 19... 22.../ 32...	
GEMA-0005	85413030001	Semi gemela Ø16 x 95 (115x60x8)		
GEMA-0006	81413030081	Semi gemela Ø20 x 110 (170x12)		

Ref. Salanguera	Ref. Or.	Descripción	Modelo	
GEMA-0001	81413036028	Gemela delantera C/C Ø30x90 / 100 x87	SERIES E F 90	
GEMA-0002	81413030073 81413036029	Gemela delantera C/C Ø30 x 100 x 27	19.../24.../25.../26... EM 202 EM 192 F 2000 F 90 G 10 G 6 G 902 L 2000 M 90	
GEMA-0003	81413036025 81413030055 81413036016 81413030064	Gemela delantera C/C Ø25 x 90 x 80	F 90 F 2000	
SOPMA-0001	81413090006	Soporte ballesta Ballesta 100mm.	19.280	
SOPMA-0009	81413016158 81413016104 81413016126 81413016156	Soporte ballesta	TGS TGX TGA	
SOPMA-0010	81413073035	Soporte ballesta Trasera parte delantera	19.280	
SOPMA-0002	81413013271 81413016115 81413010277	Soporte ballesta Delantera trasera Izqui.	19.422 40.423 40.463	

Ref. Salanguera	Ref. Or.	Descripción	Modelo	
SOPMA-0003	81413013272	Soporte ballesta	19.422	
	81413016114	Delantera ballesta Dere.	40.423	
	81413010278		40.463	
SOPMA-0004	81413013234	Soporte ballesta Delantera trasera Dere.	33.372	
SOPMA-0005	81413013233	Soportes ballesta Delantera trasera Izqui.	33.372	
SOPMA-0008	81413010253	Soporte ballesta Ballesta delantera	33.372	
SOPMA-0007	81413013220	Soporte ballesta Ballesta delantera	33.372	
SOPMA-0013	81413010257	Soporte ballesta	TGA	
	81413016095	Doble dirección		
SOPMA-0014	81413010250	Soporte ballesta	TGA	
	81413016090	Doble dirección		

Ref. Salanguera	Ref. Or.	Descripción	Modelo	
SOPMA-0012	81413010252 81413013252	Soporte ballesta Delantera parte trasera	TGA	
SOPMA-0011	81413010216	Soporte ballesta Delantera parte trasera	26.281	
SOPMA-0006	81413010160	Soporte ballesta Ballesta delantera	26.281	
SOPMA-0015	81413200089	Soporte ballesta Resbalón con guía	33.372	
SOPMA-0016	81413200089	Soporte ballesta Resbalón sin guía	40.432 40.463	
SOPMA-0017	81413200065	Soporte ballesta Resbalón antiguo	26.281	

Ref. Salanguera	Ref. Or.	Descripción	Modelo	
13.06.0110	81432706030 81432706034 81432706054 81432706076 81432706078	Tirante en V  L: 621mm. Tubo de: Ø50 Kit puntas: 13.06.0111 Kit central: 13.06.0008	TGA F 90 F 2000 SERIES E F 90 UNTERFLUR 16... 19... 22.../24...	
13.16.0111	81953016133	Kit reparación puntas:  Bola: Ø80mm Taladro: Ø23mm Distancia Ø/Ø: 152mm Ancho: 35mm	TGA F 90 F 2000 SERIES E F 90 UNTERFLUR 12.../14.../16... 17.../19... 22.../24...	
13.16.0008	81432706122 81953016132 81432706080 VOLVO: 273706  DAF: 0690320	Kit reparación central:  Bola: Ø72mm Cono: Ø38mm Largo: 46mm	TGA F 90 F 2000 SERIES E F 90 UNTERFLUR 12.../14.../16... 17.../19... 22.../24...	
13.06.0114	81432706096 81432706121 81432706114 81432206221	Tirante en V  L: 627mm. Tubo de: Ø50  Kit puntas: 13.06.0115 Kit central: 13.06.0112	TGS TGX TGA ECT	
13.06.0115	81432706118 81432706126	Kit reparación puntas:  Bola: Ø85mm Taladro: Ø23mm Distancia Ø/Ø: 130mm Ancho: 24mm	TGS TGX TGA F 2000 25... 26... 32...	
13.06.0116	81432706077 81432706081 81432706075 81432706067 81432706056	Tirante en V  L: 627mm. Tubo de: Ø50  Kit puntas: 13.06.0115 Kit central: 13.06.0112	SUSPENSIÓN NEUMÁTICA  22.../24... 18... F 90 F 2000 SERIES E	
13.06.0117	81432706087 81432706088 81432706094 81432706095	Tirante en V  L: 627mm. Tubo de: Ø48  Kit puntas: 13.06.0118 Kit central: 13.06.0119	2º EJE TRASERO 4 x 4 8 x 8 TGS / TGA / TGX / TGM F 2000 SERIES E	

Ref. Salanguera	Ref. Or.	Descripción	Modelo	
13.06.0118	81432706105  MERCEDES: 0003502805	Kit reparación puntas:  Bola: Ø85mm Taladro: Ø23mm Distancia Ø/Ø: 130mm Ancho: 24mm	TGA TGM TGS TGX ECT F 2000 SERIES E	
13.06.0119	81432706110  MERCEDES: 0003502405	Kit reparación central:  Bola: Ø100mm Taladro: Ø25mm Distancia Ø/Ø: 152mm Ancho: 24mm	TGA TGM TGS TGX ECT F 2000 SERIES E	
13.06.0121	81732706116 81432706137 81432706150	Tirante en V  L: 627mm. Tubo de: Ø50 <b>Montaje ángulo 8°</b>  Kit puntas: 13.06.0118 Kit central: 13.06.0119	TGS TGX TGA F 2000 22....	
13.06.0122	81432206327 81432206271 81432206282 81432206332 81432206314	Tirante en X  L: 572mm.  Kit puntas: 13.06.0123	TGA FAC FHLC FAS	
13.06.0123	81432206285	Kit reparación puntas:  Bola: Ø85mm Taladro: Ø25mm Distancia Ø/Ø: 130mm	TGA FAC FHLC FAS	
13.06.0124	81432206174	Tirante T-55 TGA  Largos: 644	TGA	
13.06.0127	81432706053 81432709053	Tirante en V  L: 693mm. Tubo de: Ø46	M2000  F90  M90	



## MERCEDES

Ref. Salanguera	Ref. Or.	Descripción	Modelo	
BB-4111	3043220430 3043220230	Bulón ballesta  M24/150 x Ø25 x 160	3434 L 2624	
BB-4112	3893250230 3353250030	Bulón ballesta  Ø30 x 148	NG 1626 / 1632 / 1922 NG 1926 / 1928 / 1932 NG 1935 / 1936 / 2528 NG 2536 SK 1729 / 1735 / 1831 SK 1838 / 1844 / 1844 L SK 1850 / 1850 L SK 1929 / 1935 / 1935 K SK 2031 A / 2038 / 2435	
BB-4113	3853220030 3523220430 3523220530	Bulón ballesta Ballesta de 70mm.  Ø25 x 126	ACTROS ATEGO AXOR CITARO BUS CITO BUS ECONIC LK / LN2 LP LPK LP LPKF LP LPO BUS	
BB-4114	3143250030 3953220430 3703220130	Bulón ballesta Ballesta de 90mm.  Ø25 x 140	ACTROS ATEGO AXOR CITARO BUS CONECTO BUS ECONIC LK / LN2 LP LP LP LPK MK	
BB-4115		Bulón ballesta Ballesta de 100mm.  Ø25 x 152		
BB-4117		Bulón ballesta  Ø30 x 160		
BB-4118	3953220330 3953200065 3955860032	Bulón ballesta <b>Engrase invertido</b>  Ø25 x 140	NG T2/L L T2/L LK T2/L LS	

Ref. Salanguera	Ref. Or.	Descripción	Modelo
BB-4119		Bulón ballesta Doble dirección  Ø30 x 210	
BB-4114/1	3523230376	Arandela Ø25	
BB-4114/2	0029973140	Retén Ø25	
BB-4117/1	3523230976	Arandela Ø30	
BB-4117/2	0029973040	Retén Ø30	
BB-4116	3529900337	Cuña cónica	
<b>CAPUCHINOS:</b>	CP-181402815	18 x 140	<p>Diámetro: Ø18</p> <p>Ancho cabeza: Ø28</p> <p>Altura cabeza: 15mm.</p> 
	CP-181602815	18 x 160	
	CP-181802815	18 x 180	
	CP-182002815	18 x 200	
	CP-182202815	18 x 220	
	CP-182402815	18 x 240	
	CP-182602815	18 x 260	
	CP-182802815	18 x 280	
	CP-183002815	18 x 300	
	CP-183202815	18 x 320	
	CP-183402815	18 x 340	
	CP-183602815	18 x 360	
	CP-183802815	18 x 380	
<b>CAPUCHINOS:</b>	CP-141602419ME	14 x 160	<p>Diámetro: Ø14</p> <p>Ancho cabeza: Ø24</p> <p>Altura cabeza: 19mm.</p> 
	CP-141802419ME	14 x 180	
	CP-142002419ME	14 x 200	
	CP-142202419ME	14 x 220	
	CP-142402419ME	14 x 240	
<b>CASQUILLOS:</b>	CB-253057	Ø25 x Ø30 x 57	
	CB-253067	Ø25 x Ø30 x 67	
	CB-253080	Ø25 x Ø30 x 80	
	CB-253090	Ø25 x Ø30 x 90	
	CB-253290	Ø25 x Ø32 x 90	
	CB-303567	Ø30 x Ø35 x 67	
	CB-303577	Ø30 x Ø35 x 77	
	CB-303590	Ø30 x Ø35 x 90	

Ref. Salanguera	Ref. Or.	Descripción	Modelo	
CASQUILLOS:	CB-303690	30 x 36 x 90		
	CB-304090	30 x 40 x 90		
	CB-404842	40 x 48 x 42		
CB-244596	9493200073 0003223085 0003222385	Casquillo acero bronce  24 x 45 x 87/96	ACTROS 2/3 ACTROS AXOR 2	
CB-2445140	9493200173 0003222885 0003223185	Casquillo acero bronce:  24 x 45 x 131/140	ACTROS 2/3 ACTROS AXOR 2	
M-222401	3833250112	Silleta balancín  Ballesta de 90mm.	2224 2225	
M-222402		Retén 140 x 160 x 13	2224 2226	
M-222402/1	0099975246	Retén original 143 x 165 x 12		
M-222403	A3833250151	Pista retén antiguo	2224 2226	
M-222404	3873250162	Pista reten moderno		
M-222416	3853200167	Junta de fieltro	2224 2226	

Ref. Salanguera	Ref. Or.	Descripción	Modelo	
M-222404/2		Tórica pista retén Antiguo	2224 2226	
M-222404/1	0079976048	Tórica pista retén Moderno		
M-222405	3833200084	Tapa de silleta	2224 2226	
M-222417	3833250080	Junta tapa silleta		
M-222410	0049814305	Rodamiento Interior 90mm	2224 2226 TIMKEN 32018	
M-222411	0049811805	Rodamiento Interior 88mm.	2224 2226 SKF 32018XQ	
M-222413	3939900060	Tuerca derecha eje M70/200	2224 2226	
M-222412	3933250052	Tuerca izquierda eje M80/200	2224 2226	
M-222414	3853200475	Eje centrado	2224 2226	
M-222415	3933201278	Eje descentrado		

Ref. Salanguera	Ref. Or.	Descripción	Modelo	
M-262801	6243250112	Silleta balancín Ballesta 100mm.	2628	
M-262802	0099978846 0059978447 A0099978847	Retén 170 x 190 x 8,5	2628 / 2624	
M-262803	3893251062	Pista retén	2628 / 2624	
M-262804	3893200684	Tapa silleta	2628 / 2624	
M-262804/1	3833250080	Junta tapa silleta		
M-262807	3899905060 3899905080	Tuerca derecha eje M80/200	2628 / 2624	
M-262808	3893252152	Tuerca izquierda eje M90/200	2628 / 2624	
M-262809	0029815305 0059819005 0069819205 0079810205 TIMKEN 32022	Rodamiento interior Ø90 x Ø140	2628 / 2624	

Ref. Salanguera	Ref. Or.	Descripción	Modelo	
M-262809/1	0039816805 0049810605 0079810305 SKF 320022XQ	Rodamiento exterior Ø105 x Ø170 x 38	2628 / 2624	
M-262810	0079975948	Tòrica silleta	2628 / 2624	
M-262813	3953200067	Junta de fieltro		
M-262811	0003250485 0003250985	Casquillo goma Silleta ACTROS Ø107 x 170	374, 375, 942, 943 AXOR 950, 952, 953, 958 AXOR2 950, 952, 953, 954 ACTROS	
M-262812	9473250050	Arandela nilón Silleta ACTROS Ø136 x Ø174 x 10	374, 375, 942, 943 AXOR 950, 952, 953, 958 AXOR2 950, 952, 953, 954 ACTROS	
M-262814	3953200778 3953250110	Eje descentrado	2628 / 2624	
M-250012	9473250012 9473251012	Superior silleta balancín Ø146,5	AXOR AQCTROS AXOR 2 ACTROS 2/3 ACTROS AXOR	
M-250242	9473250242	Inferior silleta balancín Ø146,5		
M-250013	9473250013	Tapa silleta	AXOR AQCTROS AXOR 2 ACTROS 2/3 ACTROS AXOR	

Ref. Salanguera	Ref. Or.	Descripción	Modelo	
SB-8060/8	6753250184	Placa separación 70 x 90 x 12	ATEGO	
SB-8060/9	6753250284	Placa separación 70 x 90 x 18,5	ATEGO	
SB-8060/91	6753250584	Placa separación 76 x 121 x 19		
SB-220084	9603220084 9603220384	Placa separación M12/125 x 84 x 112 x 16	ACTROS AROCS	
SB-220184	9603220184	Placa separación 80 x 112 x 16		
SB-8051/3	9433235384	Placa separación 84 x 110 x 18	ACTROS AXOR	
SB-236184	9433236184 9433238484 9433238584	Placa separación Tetones y ranura 84,5 x 115 x 23	ACTROS AXOR	
SB-8060	3753200844 6753250144	Placa separación M6/70,5 x 94 x 18,5	679 1324, 1324 S 677 1120, 1320, 1317 676 1117, 1317 675 1114, 1314 674 814, 914	



Ref. Salanguera	Ref. Or.	Descripción	Modelo	
SB-8060/2	6733250144	Placa separación	667 510	
		M8/65,5 x 81 x 19	668 609 D, 644 D E2	
			670 809 O, 811 D E2	
			674 814	
SB-8060/10		Placa separación		
		46 x 70 x 10 Tetón 21 x 6		
SB-8060/5	6013210062	Placa separación	611 410, 407 D, 408 D	
		70 x 50 x 8	602 309D, 310 D	
			601 208,210	
			602 209 D, 201 D	
SB-8060/6	6673250084	Placa separación	SPRINTER	
		55 x 80,5 x 14	809D, 811 D VARIO 609 D 510, 507 D, 508 D	
SB-8060/7	6733250284	Placa separación	679 1324	
		65 x 80,5 x 13	677 1120	
			676 1317	
			675 1114, 1314	
			674 814, 914	
			673 709, 809	
SB-8070/1	6743250244	Placa separación	679 1324, 1324 S	
		55,5 x 75 x 21,5	677 1320 L, 1120 LS	
			676 817 L, 1117 L	
			675 1314, 1114 S	
			674 814, 814 K	
			673 711, 811, 811 K	
SB-8070/2	6743250344	Placa separación	611 410, 407 D, 408 D	
		75,5 x 85,5 x 33	602 309 D, 310 D	
			601 208, 210	
			602 209 D, 210 D	

Ref. Salanguera	Ref. Or.	Descripción	Modelo	
SB-8070/3	9703200095	Placa ballesta 105 x 112 x 51	ATEGO ACTROS	
SB-8070/5	9703200195	Placa ballesta 105 x 117 x 90	ATEGO ACTROS	
SB-8060/12	9013250744	Goma punta 2º hoja 80x 70 x 36 x 4	SPRINTER 690 902 903 904	
SB-8071	9013222319	Goma punta 2º hoja 94,5 x 134,5 x 42,5	SPRINTER 690 901 902 903 904	
SB-8060/90	0003220244 0003220144 3753220044	Taco goma almohadilla 79 x 110	ACTROS AXOR	
SB-8215	0003330217 A0003330217  DAF: 1681114	Silent-bloc PIN Ø59,5 x 18/22 x 128	934 ACTROS 2/3 944 AXOR 945 AXOR 2	
SB-8069/3	9743200244	Silent-bloc ballesta Ø22,5 x Ø66 x 96	ATEGO	

Ref. Salanguera	Ref. Or.	Descripción	Modelo	
SB-8069/4	6753200244 6753200650	Silent-bloc ballesta Ø36 x Ø64 x 96	ATEGO	
SB-8060/3	0003250896 0003250696	Tope suspensión 120mm.	ACTROS ATEGO AXOR	
SB-8060/4	0003250596 0003250796 0003241208	Tope suspensión 150mm.	ACTROS ATEGO AXOR	
SB-185080	9053240050	Silent-bloc ballesta Ø18 x Ø50 x 80	SPRINTER 905	
SB-8061	0003210350 0003210150 0003210050	Silent-bloc ballesta Ø12 x Ø33 x 70	601 208, 210, 207 D 602 208 D, 209 D, 210 D 602 308, 310, 307 D 603 308 D, 309 D, 310 D	
SB-8065	6113240350 6113240050 6113240450	Silent-bloc ballesta Ø16 x Ø50 x 80	611 410, 407 D, 408 D 611 409 D, 410 D 690, 904 SPRINTER 905, 906 SPRINTER	
SB-8065/1	0003210250	Silent-bloc ballesta Ø16 x Ø39 x 80	SPRINTER 690, 904, 905, 906	

Ref. Salanguera	Ref. Or.	Descripción	Modelo	
SB-8066	6733200050	Silent-bloc ballesta Ø16 x Ø46 x 96	673 709, 711, 809..... 674 814,914 KO, 917 AK 675 1114/K, O 1114.... 676 817 F, 917 AK, 1117.. 677 1120 S, OB1120, 678 914	
SB-8066/1	6753250485 9703200344	Silent-bloc ballesta Ø18 x Ø56 x 96	ATEGO 375 ATEGO 958, 970, 972 ATEGO 974, 975, 976	
SB-8067	6753200050	Silent-bloc ballesta Ø18 x Ø48,5 x 96	O, 1120 L 814 AK, 914 AK, O 814 L, 814 LO 1314, 1317 K, 1514	
SB-165095	9703200044 9703200144	Silent-bloc ballesta Ø16 x Ø50 x 95,5	ATEGO	
SB-8068	3103200050	Silent-bloc ballesta Ø30 x Ø52 x 77	L 608 D, LK 608 D, LF 508 D O 309 D, L613 D LO 608 D, L 608 K	
SB-8068/1	6703200444	Silent-bloc ballesta Ø30 x Ø52 x 86,5	O 814 R LO 814 510, 507 D, 508 D,K 609D 709 D, 711 D 809 D 811 DK, 814 D/DA 914/42 709, 710, L 710 D	
SB-8069	6703200344	Silent-bloc ballesta Ø36 x Ø58 x 86,5	VARIO 669 809D, 811 D/DK, 814 D/DA	

Ref. Salanguera	Ref. Or.	Descripción	Modelo	
SB-8069/1	6733200150	Silent-bloc ballesta Ø36 x Ø58 x 96	673 709,711,809... 674 814, 914 KO, O 814 675 O,1114, 1114 676 817, 917, 1117	
SB-8070	6753200150	Silent-bloc ballesta Ø36 x Ø63,5 x 96		
SB-8072	9743200044	Ø22,5 x Ø 63,5 x 96	Con casquillo reductor	
SB-8069/2	6733200250	Silent-bloc ballesta Ø36,5 x Ø58,5 x 48	673 709,711,809... 674 814, 914 KO, O 814 675 O,1114, 1114 676 817, 917, 1117 677 1120, 1124, O1120 678 914, 1114, 1117	
SB-32158114 AR	9463280476	Arandela acero 22'7 x 73 x 11/10/30		
SB-5817804	9463280076	Arandela NYLON Ø58,75 x Ø178 x 4,7		
SB-32158114	9463900250	Silent-bloc brazo Oscilante Ø31,5 x Ø158 x 114		
SB-32160092	9463900150	Silent-bloc brazo Oscilante Ø31,5 x Ø160 x 92		
SP-9104	9463900050	Silent-bloc brazo Oscilante Ø31,5 x Ø152 x 171		
	SAF: 4177302600			
SB-8063	0003220385 0003220585	Silent-bloc ballesta Ballesta: 80mm. Ø22 x Ø60 x 68 x 76	MK SK	
SB-8064	0003221285 0003222285 0003223285 0003223485 3753220185 5010557698	Silent-bloc ballesta Ballesta: 90mm. Ø24 x Ø62 x 80 x 96	ACTROS ATEGO AXOR ECONIC SK	

Ref. Salanguera	Ref. Or.	Descripción	Modelo		
SB-8064/1	0003250285	Silent-bloc ballesta	ACTROS		
	0003250785	Ballesta: 100mm.			
	0003250885				
	0003251385	Ø24 x Ø62 x 90 x 106			
SB-8063/1	0003220985	Silent-bloc ballesta	625	3229 /B/K	
	0003220885	Ø22 x Ø60,5 x 44 x 50	626	323 B/K, 3234 B/K	
SB-8064/2	0003221985	Silent-bloc ballesta	652	1722 L, 1733 L	
			653	2433 L, 2534 L	
		Ø24 x Ø62 x 78 x 86	657	253 LS, 2429 LS	
SB-200544	9743200544	Silent-bloc ballesta	ATEGO		
		Ø22 x Ø62 x 96			
SB-231285	9603231285	Silent-bloc ballesta	ACTROS ANTOS		
		Ø24 x Ø67 x 96			
SP-2457100102	3713280250	Silent-bloc ballesta	AKSOR		
		Metal-goma-metal			
		Ø24 x Ø57 x 100 x 102			
	BPW: 17498603				
SB-2462104	0009980142	Silent-bloc ballesta	AROS ANTOS		
	9603231685	Ø24 x Ø62 x 80 x 104	ACTROS MP4		
	9603234585				
	9603232965				

Ref. Salanguera	Ref. Or.	Descripción	Modelo	
24.16.0251	9743270181	Silent bloc barra estabilizadora Ø22 x Ø68 x 60	ATEGO	
24.16.0252	0003262381 0003262281 0003262781	Silent bloc barra estabilizadora Ø32 x Ø60 x 52	MK NG SK	
24.16.0253	0003263781 0003263681 0003263881	Silent bloc barra estabilizadora Ø18,5 x Ø60 x 52	MK NG SK	
24.16.0255	0003237985 0003237485 0003237585	Silent bloc barra estabilizadora Ø40 x Ø70 x 46,5	ACTROS AXOR	
24.16.0256	9743200444	Silent bloc barra estabilizadora Ø16 x Ø39,5 x 40	ATEGO	
24.16.0257	0003238185	Silent bloc barra estabilizadora Ø40 x Ø80 x 46	ACTROS ACTROS / AXOR 2	
24.16.0258	6583260581	Silent bloc barra estabilizadora Ø51,5x Ø89 x 60	OH 1621 L OH 1625 L, OH 1628 L OH 1628 L OH 1625 L OH 1630 L OH 1835 L / 30 1722 L 2433 L 2420 L	

Ref. Salanguera	Ref. Or.	Descripción	Modelo	
24.16.0261	6533260481	Silent-bloc barra estabilizadora Ø16 x Ø68 x 60	MK SK	
24.16.0262	6313230044	Silent-bloc barra estabilizadora Ø11 x Ø32 x 29,5	MB 100 D O 100 CITY	
24.16.0263	9743280181	Silent-bloc barra estabilizadora Ø22 x Ø74,5 x 40	ATEGO	
24.16.0264	6023210050 6023210250	Silent-bloc barra estabilizadora Ø16 x Ø26,5 x 26	601.062 602.423	
24.16.0265	6013210350	Silent-bloc barra estabilizadora Ø12 x Ø26 x 26	SPRINTER UNIMOG 601.210 D 668.669 D	
24.16.0266	6553230085	Silent-bloc barra estabilizadora Ø48 x Ø71,5 x 41	1722 L 2433 L 1831 L 1834 L 1838 L 1844 L 1748 L 1831 LS 1838 LS	
24.16.0267	6583230085	Silent-bloc barra estabilizadora Ø31 x Ø68 x 60	1722 L 2433 L 1831 L 2538 LS 2544 LS 2550 LS 2531 L 2538 L	



Ref. Salanguera	Ref. Or.	Descripción	Modelo	
24.16.0268	3093200073 3143260153	Silent-bloc barra estabilizadora Ø12 x Ø28,5 x 30	ATEGO, AETGO 2 MB 100 D MB 140 D 709 D	
24.16.0269	6673200073	Silent-bloc barra estabilizadora Ø12 x Ø32,5 x 36	SPRINTER ACCELO 709 D, VARIO LO 814 609 D	
24.16.0270	3183200073	Silent-bloc barra estabilizadora Ø16 x Ø34 x 40	ATEGO ATEGO 2 UNIMOG 405,418,427,436 809 DT, 811 DT 814	
24.16.0288	3173331164 3173330964	Casquillo barra estabilizadora Ø53,5 x Ø82/Ø85,5 x 40	O 030 O304 O 305 O 317	
24.16.0274	9413230350	Ø40 x Ø52 x 24	ACTROS ATEGO	
24.16.0275	3143260481	Ø18 x Ø26,5 x 14,5	LK/LN2 LP LPK	
24.16.0276	6203230250	Ø25,2 x Ø35 x 25	T2/L T2/LN1 VARIO	
24.16.0277	0003230950	Ø25 x Ø35 x 28	2626, 2626 S 2632	
24.16.0278	6203230050	Ø25 x Ø35 x 30,5	2219 1919	
24.16.0279	0003260250	Ø32 x Ø44 x 35	2636	
24.16.0280	3873260050	Ø32 x Ø44 x 36,5	1922 K, 1935 S/35 LS/35... OH 1622, 1625	
24.16.0281	0003232150	Ø32,5 x Ø44 x 25	1729 S, OH 1416 2517, 2521	
24.16.0282	6173260050	Ø35 x Ø55 x 19	1214, 1217, 1222 1935, 1944, 1831, 1834, 2631 1419 S	

Ref. Salanguera	Ref. Or.	Descripción	Modelo	
24.16.0283	0003260650	Ø40,5 x Ø52 x 25	1817, 1821, 1626, 1632 1222, 1225, 1633, 1636, 1638 2429, 2544	
24.16.0284	6203230150	Ø58,5 x Ø70 x 19	1628 L, 1633 L, 1928 L, 1933 LS	
24.16.0285	6203230350	Ø44 x Ø56 x 25	2228 L, 2233 L 2650 /S 2235 L, 2244 L/LL, 3235	
24.16.0286	3603230151	Casquillo barra estabilizadora Ø39,5 x Ø65 x 22	2229 1413 1219 1017, 1019 LA 1513 L 1313	
24.16.0287	3603230085	Casquillo barra Ø39 x 37	OF 1114, 1214 L 1313, LA 1314, LG 1819 L 1514, LS 1526, OH 1314 LT 911 B	
24.16.0249	3873230285	Casquillo barra Ø37 x 70 x 62		
24.16.0289	9423260050	Silent-bloc barra estabilizadora Ø88 x Ø20,5/130	ACTROS ATEGO AXOR ECONIC	
24.16.0290	9413230050	Silent-bloc barra estabilizadora Ø73,5 x Ø19/100	ACTROS AXOR UNIMOG ECONIC	
24.16.0292	0003233285	Ø36,5 x 70 x 63,5	LPS 1924 LS 1934	
24.16.0293	0003260881	Ø40 x 70 x 63,5	LP 2226/6x4 LPK 2232/6x4	
24.16.0294	0003260981	Ø45,5 x 70 x 70		
24.16.0295	3163230185	Ø29 x 36 x 38	LP 608, 709 LPK 608, 709	
24.16.0296	3183210585	Ø38 x 50	LPKF 608, 709 LPKO 608, 709	
24.16.0297	3183210085	Ø25,5 x 35 x 37,5	L 508 DG L 608 D LPC 811, 813	

Ref. Salanguera	Ref. Or.	Descripción	Modelo	
24.16.0298	3143230285	Casquillo barra estabilizadora Ø12 x Ø28,5 x 30	LPK 608, 709 LPKF 608, 709 LPKO 608, 709 LPO 608, 709 LPS 608, 709	
24.16.0299	6383230285	Ø24 x 35 x 46	VITO VIANO SPRINTER	
24.16.0300	9043260981	Ø30 x 46 x 50		
24.16.0301	9043260881	Ø27 x 46 x 50		
24.16.0302	9013230185	Ø22 x 30,5 x 39	SPRINTER 310 D, 312 D	
24.16.0303	9043230085	Ø25 x 30,5 x 39	311 GDI, 313 GDI, 412 D VITO	
24.16.0304	6383260281	Ø13,5 x 35 x 46		
24.16.0305	9063260781	Ø16 x 35	SPRINTER	
24.16.0306	9063231485	Ø20 x 35		
24.16.0307	9063260881 9063260281	Ø20 x 35		
24.16.0308	9063231685	Ø23 x 35	SPRINTER	
24.16.0309	9063260481	Ø32 x 25		
24.16.0310	9043261081	Ø33 x 46 x 50		
24.16.0311	6753232185	Ø38,5 x 56	1114 AK, 1317 AK, 1414 AK 1117 A, 1117 AK, 1317 AK	
24.16.0312	6753231685	Ø43 x 56	1320 AK, 1324 AK 917 AF / LAF	
24.16.0313	6753260581 6753260281	Ø47 x 56	1120 AF, 1124 AF O 1114	
24.16.0314	6753231785	Ø35 x 56	917 AK, 914 AK 1114 AK, 1317 AK, 1314 AK	
24.16.0315	6753260981	Ø41 x 56	1117 A, 917 AK 1120 S, 1320 S, 1324 S	
24.16.0316	6743280281 6743280081	Ø44 x 56	1114 L, 1117 L/LS 1117 L, 1120 L, 1121 L	

Ref. Salanguera	Ref. Or.	Descripción	Modelo	
24.16.0317	6113260081	Ø32 x 58	410, 407 D/408 D 409 D/410 D 207 D/208 D 307 D/308 D SPRINTER	
24.16.0318	6013260482	Ø24 x 38		
24.16.0319	9013260081	Ø22 x 38		
24.16.0320	6753261281	Ø47 x 55,5	154 K, O 1114 917 AF/LAF, 157 /K 814 L	
24.16.0321	6753260181	Ø40 x 56	1114 S/K, 1314 K, 1317 K 1117 S, 1317 S, 817 L/LS 137 L/S	
24.16.0322	6743280381	Ø45,5 x 56		
24.16.0326	6703230385	Ø40 x 53	VARIO 814 DA SPRINTER	
24.16.0327	6673261381	Ø41 x 60		
24.06.0328	6673261481	Ø46 x 60		
24.16.0329	6673261581	Ø50,5x 60	VARIO	
24.16.0330	6753230485	Ø35 x 59,5	814 KO, 914 KO 1114 /K/S 1117 /L/LS, 917 KO 1514 L 1517 I917 AF 709, 711 709 K 809 K	
24.16.0331	6753231585	Ø42 x 59,5		
24.16.0332	6733230585	Ø35 x 60		
24.16.0333	6753231485	Ø35 x 59,5	1114 K/L, O 1114 L 1117 K/L/LS/LO 1117 L, 1120 L/LS, 1121 L O 814 /L, 814 F/LO O 817 /L, 817 F/LO 711, 709	
24.16.0334	6733230685	Ø35 x 60		
24.16.0335	6733230485	Ø28 x 60		
24.16.0336	6733230385	Ø28 x 60	811 /K, 809 /K 814 /K, 814 L, 914 AK 817 /F/K/L/LS/S 917 /K	

Ref. Salanguera	Ref. Or.	Descripción	Modelo	
24.16.0337	3143260381	Ø29,5 x 40 x 62	LPL 608, 709, LPLS 608 LPKF 808, 809, LPO 808 LPO 808, 809, LPL 808. 809	
24.16.0338	3163260081	Ø35 x 40 x 62	LPKF 608, 709 LPKO 608, 709	
24.16.0339	3143260081	Ø30 x 40 x 56,5	LPD 608, 709	
24.16.0340	3183260081	Ø38 x 40 x 62	LPL 809, 808 LPK 1013 LPL 813, 913, 1013 LPLS 813 LPS 811, 813 508 I	
24.16.0341	3093230385	Ø30 x 50	L/LO 608 D, L 708 L 406 DG, L 407 D, L 408 L 608 D, LK 08 D	
24.16.0342	6673230585	Ø34,5 x 50	809 D, 811 D/DK 814 D, VARIO	
24.16.0343	6673230485	Ø29,5 x 50	609 D, 709 D, 711 D 709 L 710 D	
24.16.0344	3093230285	Ø25 x 50	L 406 DG, 407 D LF 408 G, 409, 410 LK 406 DG, 407 D	
24.16.0345	6673230685	Ø36 x 50	VARIO O 814 R/S 712 E, 912, 913 L 913 D	
24.16.0346	6673230385	Ø26 x 50	510, 507 D, 508 D/DK VARIO	
24.16.0347	6673230285	Ø30 x 50,5		
24.16.0348	6023260482	Ø30 x 49	208, 210, 207 D 208 D, 209 D, 210 D 410, 407 D, 408 D	
24.16.0349	6023260882	Ø30,5 x 49	409 D, 410 D 308/310, 307 D, 308 D	
24.16.0350	6023260282	Ø33 x 49	309 D, 310 D	
24.16.0351	6733260281	Ø36 x 46	709 K, 809 K, 811 K 814 F/K/S 817 K/S/F	
24.16.0352	6733260681	Ø38,5 x 46	914 K/KO, 814 F/KO 917 K/KO, 817 F	
24.16.0353	6733260781	Ø45 x 46	814 F 817 F, 917 AF/LAF O 301, 402	

Ref. Salanguera	Ref. Or.	Descripción	Modelo	
24.16.0354	6753260681	Ø44,5 x 59,6	O 814 L, 814 K 1114 L	
24.16.0355	6753260781	Ø50 x 59	817, 117 L/LS, 1317 L/LS O 1120 L, O1114 L	
24.16.0356	6753232085	Ø37,5 x 59,6	O 1117 L, 1114 K, 1314 K, 1317 K 1117 K, 1317 K, 1320 K 914, 1114, 1117	
24.16.0357	6763260481	Ø56 x 60	1514 L, 1517 L, 1520 L 1524 L, 2020 L, 2024 L	
24.16.0358	6763230085	Ø43,5 x 59,6		
24.16.0359	6753231285	Ø35 x 59,5	1314 K, 1317 K 1317 L/LS 1320 L/LS	
24.16.0360	6743260081	Ø41,5 x 59,5	914, 1114, 1117 814 L, 817 L/LS	
24.16.0361	6763260581	Ø62 x 60	1514 L 1517 L 917 AF, 917 LAF 1520 L	
24.16.0362	6553260481	Ø69,5 x 65,5	1928 L/LS, 1933 LS, 1936 LS 1938 LS, 2428 L	
24.16.0363	6553260581	Ø64 x 65,5	1935 LS, 1944 LS, 2244 LS 1628 L, 1633 L, 1636 L	
24.16.0364	6533260381	Ø44 x 60,5	2028, 2033, 2036 LS 2228 L, 2236 L, 3038. 1722L, 1733 L, 1834 L 2433 L, 2534 L 2522 L, 2524 L, 2527 L	
24.16.0368	0003262481	Ø39 x 56	AXOR, AXOR 2 ACTROS, ACTROS 2	
24.16.0369	0003262681	Ø48 x 56,5	ATEGO, ATEGO 2 UNIMOG	
24.16.0370	9743230285	Ø37,5 x 56		
24.16.0371	9743230385	Ø42 x 55,5	ATEGO AXOR 2 ACTROS	
24.16.0372	0003264481	Ø57,5 x 56		
24.16.0373	0003250685	Ø52 x 56		
24.16.0374	0003236285	Ø28,5 x 55,5	ACTROS AXOR 2	
24.16.0375	0003235885	Ø35 x 56,5	1831, 1840 1935	
24.16.0376	6753232385	Ø43 x 64	1222 /F/S/LS, 122 F 1417 K, 1420 L, 1424 L 2422 L, 2426 L 154 K/L	

Ref. Salanguera	Ref. Or.	Descripción	Modelo	
24.16.0377	3093260481	Ø37 x 84	L/LO 608 D, LO 708 D/E O 309 B/D, L 508 DG L 608 E, LO 608 D	
24.16.0378	3093260281	Ø34 x 84	L/LO 608 D, LO 708 D/E LF 408 G, 409, 410	
24.16.0379	5683260381	Ø37 x 56	L 608 E, LO 608 D 2429, 2434, 2435	
24.16.0442	6673261081	Ø46 x 60	VARIO 1120 F, 1124 AF/F 709 D	
24.16.0443	6753231385	Ø41,5 x 59,5	809 D, 811 DK, 814 DA	
24.16.0444	6673260681	Ø46 x 80		
24.16.0445	6673260081	Ø36 x 80	507 D, 508 DK 609 D	
24.16.0446	6693260081	Ø50 x 80	VARIO O 814 R/S LO 814	
24.16.0447	6673260181	Ø46 x 80	507 D/508 DK 609 D, LO 812, OF 812	
24.16.0380	0003261781	Ø56 x Ø86 x 63	2226 / 6 x 4 2226 S / 6 x 4 2232 / 6 x 4	
24.16.0381	0003261581	Ø50,5 x Ø86 x 63	1626 L/LS 1632 L/LS 2226 LS / 6 x 4	
24.16.0382	4353230085	Ø32,5 x Ø70 x 62	1300 L	
24.16.0383	6253230085	Ø55 x Ø70 x 62	3235 / 3535 AK 3538 / 3544 AK/K 3550 / 5038 AK	
24.16.0384	0003233785	Ø37 x Ø70 x 62	LS 1924, 1928 2219 L / 6 x 4	
24.16.0394	6213230085	Ø35 x Ø70 x 62	1626, 1632 AK 1831, 1834, 1626, 1632 2517, 2521	
24.16.0386	0003233985	Ø41 x Ø70 x 62	1626 K, 1626 AS, 1632 AK 1926 A, 1926 AK, 1936 AS 2226 L / 6 x 2	
24.16.0388	3873230185	Ø46 x Ø70 x 62	2229 / 6 X 4 1719 S/K	
24.16.0389	6173230085	Ø51 x Ø70 x 62	2216, 2225, 2222, 2025 S 3025, 3025 K 3028 3228 B, 3228 K	
24.16.0390	0003261681	Ø45 x Ø86 x 63	LPS 1924, LS 1924 LP 2226 / 6 x 4	
24.16.0392	3873260181	Ø50,5 x Ø86 x 63	1626/ AK / AS / K / S 1626, 1632 2238, 2236 L	
24.16.0393	3933260481	Ø56 x Ø86 x 63	2233, 2429, L 2638	





Ref. Salanguera	Ref. Or.	Descripción	Modelo	
24.16.0396	3933260281	Ø65 x Ø86 x 90	1017 LS, 1217 L/ LS 1419 L, 1424 LS, 1613 L 1626 / 1632 L/LS	
24.16.0397	3933260381	Ø60 x Ø86 x 90	2226 6x4 2226LS	
24.16.0398	3893260081	Ø70 x Ø86 x 90	2232 6x4 2232 LS 1629 LS	
24.16.0399	3833260181	Ø51 x Ø81,5 x 100,5	O 303 LP 1114, 1214 A LS 1524, 1525 OF 1313, 1317, 1413, 1417 OF 1617, 1621 OF 1113 O 370, 371 1013 KO	
24.16.0400	3013260081	Ø50 x Ø82 x 80	1218 / 1318 / 1418 1218 / 1620 O 500 1636 / 1517 O 303 O 400	
24.16.0291	9413260050	Silent-bloc Central Ø82 x Ø110 x 66,5	ACTROS ATEGO AXOR ECONIC	
24.16.0405	9703231585 9583200144 9793200444 9743230085	Silent-bloc central Ø33.5 x 47.5	ATEGO	
SOPME-0001		Placa reglaje soporte Ø30 x 220 x 155 x 8		
SOPME-240401	9463206878	Soporte ballesta 250mm	MERCEDES-JOST	
SOPME-0019	9463206678	325mm Chasis a centro bulón		









Ref. Salanguera	Ref. Or.	Descripción	Modelo	
SOPME-0002	6553220601	Soporte ballesta Delantera	AXOR 2 ACTROS 2/3 26222 2628 3031	
SOPME-0003	6203220501 6203220901	Soporte ballesta Eje delantero 4 Taladros	2622 2628 3031	
SOPME-0004		5 Taladros		
SOPME-0005	3753220103 9413220203	Soporte ballesta Delantera, trasera	AXOR ACTROS 1840 2523 2528 3228 3340	
SOPME-0006	6203220103 6203220003	Soporte ballesta Ballesta delantera, Parte trasera	L 1933, L 2635 1729, 2623 2622, 3031	
SOPME-0008	6523200070	Soporte ballesta Ballesta delantera, Parte trasera	3224 3234	
SOPME-0016	3873250001	Soporte ballesta Ballesta trasera	1935 2622	
SOPME-0018	3753250001	Soporte ballesta Ballesta trasera	2523 2528	

Ref. Salanguera	Ref. Or.	Descripción	Modelo	
SOPME-0017	6213250003	Soporte ballesta Trasero Izquierdo	1935 L 1929 1628 1938 1635 1944 2035	
SOPME-0017/1	6213250004	Soporte ballesta Trasero Derecho	1935 L 1929 1628 1938 1635 1944 2035	
SOPME-220401	9303220401	Soporte ballesta Izquierdo	ACTROS	
SOPME-220501	9303220501	Soporte ballesta Derecho	ACTROS	
SOPME-201327	9493201327	Soporte gemela Trasero Izquierdo	ACTROS AXOR	
SOPME-201427	9493201427	Soporte gemela Trasero Izquierdo	ACTROS AXOR	
SOPME-201127	9493201127	Soporte gemela Delantero Izquierdo	ACTROS AXOR 1328 3340 4140	

Ref. Salanguera	Ref. Or.	Descripción	Modelo	
SOPME-201227	9493201227	Soporte gemela Delantero derecho	ACTROS AXOR 1328 3340 4140	
SOPME-0009	6253250219 6243250219	Soporte resbalón  Delantero Izquierdo Trasero Derecho	AXOR 3028 3235 3238 2029 2235 2429 2538	
SOPME-0010	6253250319 6243251119	Soporte resbalón  Delantero Derecho Trasero Izquierdo	AXOR 3028 3235 3238 2029 2235 2429 2538	
SOPME-0011	6593250319	Soporte resbalón  Delantero Derecho Trasero Izquierdo	2624 2628 3235 3236 3244 3250 3538 3820	
SOPME-0012	6593250219	Soporte resbalón  Delantero Izquierdo Trasero Derecho	2624 2628 3235 3236 3244 3250 3538 3820	
SOPME-0013	3433250040	Taco goma Soporte resbalón	2624 2628 3235 3236 3244 3250 3538 3820	
GEME-0002	6173200163 3523200063	Gemela Ø25 x 70/93	2517 2521	

Ref. Salanguera	Ref. Or.	Descripción	Modelo	
GEME-0003	3873200162 3703200062	Gemela Ø25 x 90/95	2622 2628 3031 L2638	
GEME-0004	3463205063	Gemela 125mm.	1935 2628	
GEME-0006	3523200163	Gemela Ø30 x 80/102	1513	
GEME-0001	6993200362 6993220220 6243200062	Gemela doble dirección	3328 3050 3538 3553 3235	
GEME-0008		Kit gemelas Ø22 x 150mm.		
GEME-0009	6553250120	Semigemela plana Ø24 70x15 125		
GEME-0010		Semigemela plana Ø18 72x8 125		

Ref. Salanguera	Ref. Or.	Descripción	Modelo	
GEME-250320	9413250320	Semi-gemela	1840 2523 2528 3228 3340	
GEME-220020	9413220020	55 x Ø18 M24,2 x 115 70 x Ø14 M24,2 x 115	AXOR ACTROS	
TA-20260ME	910105020035	Tornillo amarre: M20/150 x 260	ACTROS	
TA-20280ME	910105020036	Tornillo amarre: M20/150 x 260		
ALME-0001	9413310426 9413310126	Placa asiento abarcón	ACTROS AXOR	
SB-8060/90	0003220044	Goma almohadilla Placa asiento	ACTROS AXOR	
ALME-0002		Placa asiento abarcón		
ALME-0003	6243510026	Placa asiento abarcón	2628 3031	
PLAME-00001	9473250426 9583250026 9473250226	Placa fijación del tope asiento	ACTROS ATEGO AXOR	

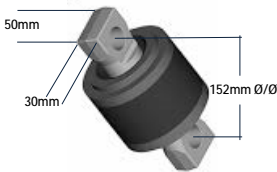
Ref. Salanguera	Ref. Or.	Descripción	Modelo	
100706001	9423500805 9423500505 9423501205	Tirante en V L: 622mm.  Kit puntas: 100706003 Kit central: 100706002	AXOR ACTROS	
100706002	0003503105 0003504005 0003504405 0003504450	Kit reparación central:  Bola: Ø85mm Taladro: Ø25mm Distancia Ø/Ø: 152mm Ancho: 24mm	ACTROS AXOR ECONIC	
100706003	0003503305 0003504805	Kit reparación puntas:  Bola: Ø85mm Taladro: Ø23mm Distancia Ø/Ø: 130mm Ancho: 24mm	ACTROS AXOR	
100706004	9423501505 9473501005 9423501005 9473500105 9443500005	Tirante en V L: 622mm.  Kit puntas: 100706005 Kit central: 100706002	ACTROS ANTOS AROCS ATEGO AXOR ECONIC	
100706005	0003502205 0003504505	Kit reparación puntas:  Bola: Ø75mm Taladro: Ø25mm Distancia Ø/Ø: 130mm Ancho: 24mm	ACTROS ANTOS AROCS ATEGO AXOR ECONIC	
100706006	9483502205 9483502705 9483501705	Tirante en V <b>REFORZADA Tubo 60Ø</b> L: 621,5mm.  Kit puntas: 100706007 Kit central: 100706008	374 AXOR 940/942 AXOR 2 943/944 AXOR 2 958 AXOR 2 950/952 ACTROS 953/954 ACTROS 930/932 ACTROS 933/934 ACTROS	
100706007	0003503605	Kit reparación central:  Bola: Ø108mm Taladro: Ø25mm Distancia Ø/Ø: 152mm Ancho: 30mm	374 AXOR 940/942 AXOR 2 943/944 AXOR 2 958 AXOR 2 950/952 ACTROS 953/954 ACTROS 930/932 ACTROS 933/934 ACTROS	

Ref. Salanguera	Ref. Or.	Descripción	Modelo			
100706008	0003503705	Kit reparación puntas:	374	AXOR		
			940/942	AXOR 2		
			943/944	AXOR 2		
		Bola:	Ø85mm	958		AXOR 2
		Taladro:	Ø23mm	950/952		ACTROS
		Distancia Ø/Ø: 130mm	953/954	ACTROS		
			930/932	ACTROS		
100706009	9483502305	Tirante en V		ACTROS		
	9483500905	L: 667mm.		AXOR		
		Kit puntas: 13.06.0118				
		Kit central: 100706024				
100706024	0003502905	Kit reparación central:		ACTROS		
				AXOR		
		Bola:	Ø108mm			
		Taladro:	Ø25mm			
		Distancia Ø/Ø:	152mm			
		Ancho:	24mm			
13.06.0118	0003502805	Kit reparación puntas:		ACTROS		
				AXOR		
		Bola:	Ø85mm			
		Taladro:	Ø25mm			
		Distancia Ø/Ø:	130mm			
		Ancho:	24mm			
	MAN: 81432706105					
100706010	9483503005	Tirante en V		ACTROS		
	3753500205	L: 662mm.		AXOR 2		
	9483501105					
	9483500405	Kit puntas: 100706012				
		Kit central: 100706011				
100706011	0003504905	Kit reparación central:		ACTROS		
				AXOR 2		
		Bola:	Ø100mm			
		Taladro:	Ø25mm			
		Distancia Ø/Ø:	152mm			
		Ancho:	24mm			
100706012	0003504505	Kit reparación puntas:		ACTROS		
				AXOR 2		
		Bola:	Ø75mm			
		Taladro:	Ø25mm			
		Distancia Ø/Ø:	130mm			
		Ancho:	24mm			

Ref. Salanguera	Ref. Or.	Descripción	Modelo		
100706020	9423500105	Tirante en V	950	ACTROS/AXOR 2	
	9423501105	L: 622mm.	930	ACTROS	
	9423501605		940	AXOR	
	9423500705	Kit puntas: 100706022	375	AXOR	
	3753500105	Kit central: 100706021	957	ECONIC	
100706021	0003504605	Kit reparación central:	950	ACTROS/AXOR 2	
	0003502105	Bola: Ø75mm	930	ACTROS	
		Taladro: Ø25mm	940	AXOR	
		Distancia Ø/Ø: 152mm	375	AXOR	
		Ancho: 24mm	957	ECONIC	
100706022	0003504705	Kit reparación puntas:	950	ACTROS/AXOR 2	
		Bola: Ø67mm	930	ACTROS	
		Taladro: Ø23mm	940	AXOR	
		Distancia Ø/Ø: 130mm	375	AXOR	
		Ancho: 24mm	957	ECONIC	
100706023	9443500505	Tirante en V	950	ACTROS/AXOR 2	
	9443500305	L: 622mm.	952	ACTROS/AXOR 2	
	9443500605		953	ACTROS/AXOR 2	
	9473500705		954	ACTROS	
	9473500905	Kit puntas: 100706005	930	ACTROS	
		Kit central: 100706002	932	ACTROS	
			933	ACTROS	
			934	ACTROS	
100706019	6713330105	Tirante			
	3573330405	L: 624mm.	357 O 405		
			612 O 405		
			671 O 345 CONECTO		
		Kit reparación: 100706013			
100706013	0003302511	Kit reparación:			
	0003302611		357 O 405		
		Ø56 x Ø15/90 c/c	612 O 405		
			671 O 345 CONECTO		
100706025	9483501905	Tirante Inferior Trasero		ACTROS, AXOR, ATEGO,	
	9483501305	L: 565mm.		AROCS	
	3753500206				
	3753500106				
	9483501205	Kit reparación:			
	9473500805	OR: 0003502705			



## ACTROS-AXOR 6x4, 6x6, 8x4, 8x6, 8x8



FIGURA	O.R.	DESCRIPCIÓN	R. SALANGUERA
130	9473250050	Arandela nilón	M-262812
120	0003250485	Casquillo goma silleta	M-262811
100	9473250012	Superior silleta balancín	M-250012
110	9473250242	Inferior silleta balancín	M-250242
140	9473250013	Tapa silleta	M-250013

## 2224-2225 Ballesta 90mm

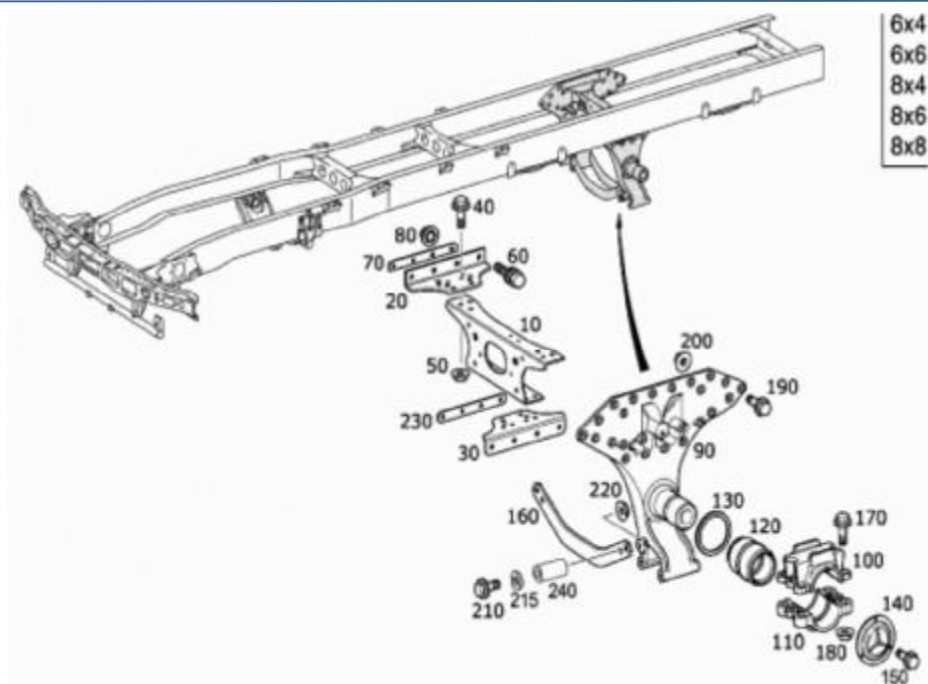

FIGURA	O.R.	DESCRIPCIÓN	R. SALANGUERA
825	3833250112	Silleta balancín	M-222401
831	0099975246	Reten silleta 143 x 165 x 12	M-222402/1
821	A 3833250151	Pista reten antiguo	M-222403
821	3873250162	Pista reten moderno	M-222404
841	3833200084	Tapa silleta	M-222405
829	0049814305	Rodamiento 90mm.	M-222410
835	0049811805	Rodamiento 88mm.	M-222411
839	3939900060	Tuerca derecha eje M70/200	M-222413
837	3933250052	Tuerca izquierda eje M80/200	M-222412
815	3853200475	Eje centrado	M-222414
820	0079976048	Junta torica	M-222404/1
823	3853200167	Junta de fieltro	M-222416
833	0119973746	Reten silleta 143 x 165 x 12	M-222402/1
843	3833250080	Junta tapa silleta	M-222417

## 2628 Ballesta 100mm





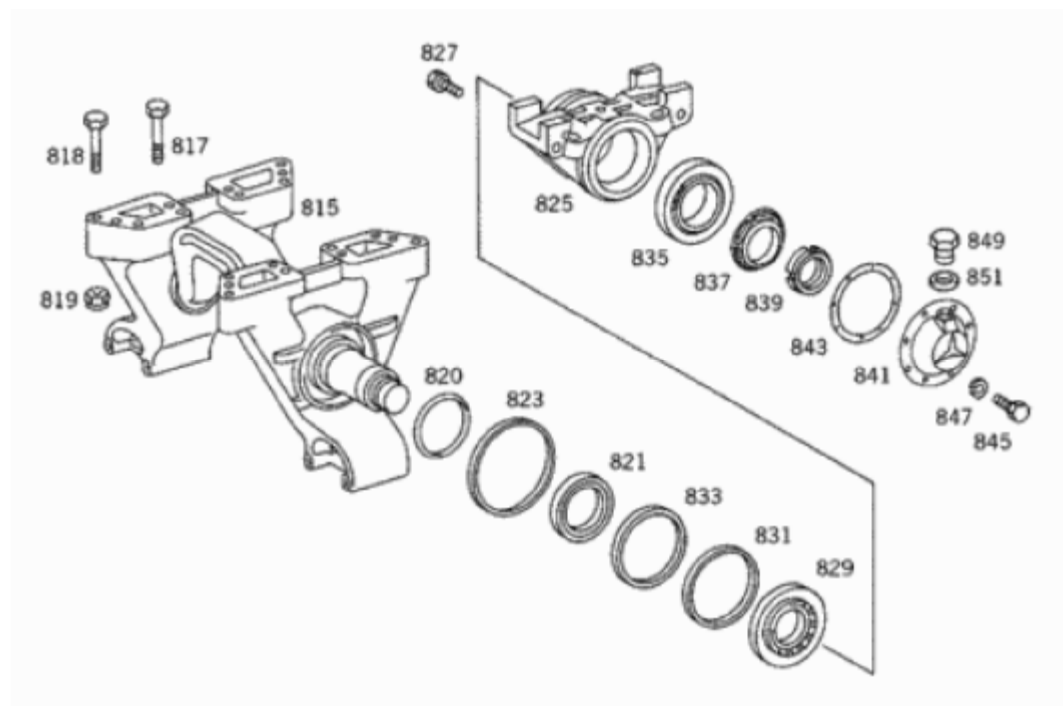

FIGURA	O.R.	DESCRIPCIÓN	R. SALANGUERA
23	6243250112	Silleta balancín ballesta 100mm.	M-262801
20	3953200067	Junta de fieltro	M-262813
14	0079975948	Torica silleta	M-262810
17	3893251062	Pista reten	M-262803
29	0099978846	Reten	M-262802
26	0029815305	Rodamiento interior	M-262809
35	0039816805	Rodamiento exterior	M-262809/1
32	0099978846	Reten	M-262802
38	3893252152	Tuerca izquierda eje	M-262808
41	3899905060	Tuerca derecha eje	M-262807
44	3833250080	Junta de tapa silleta	M-262804/1
47	3893200684	Tapa silleta	M-262804

R.V.I.

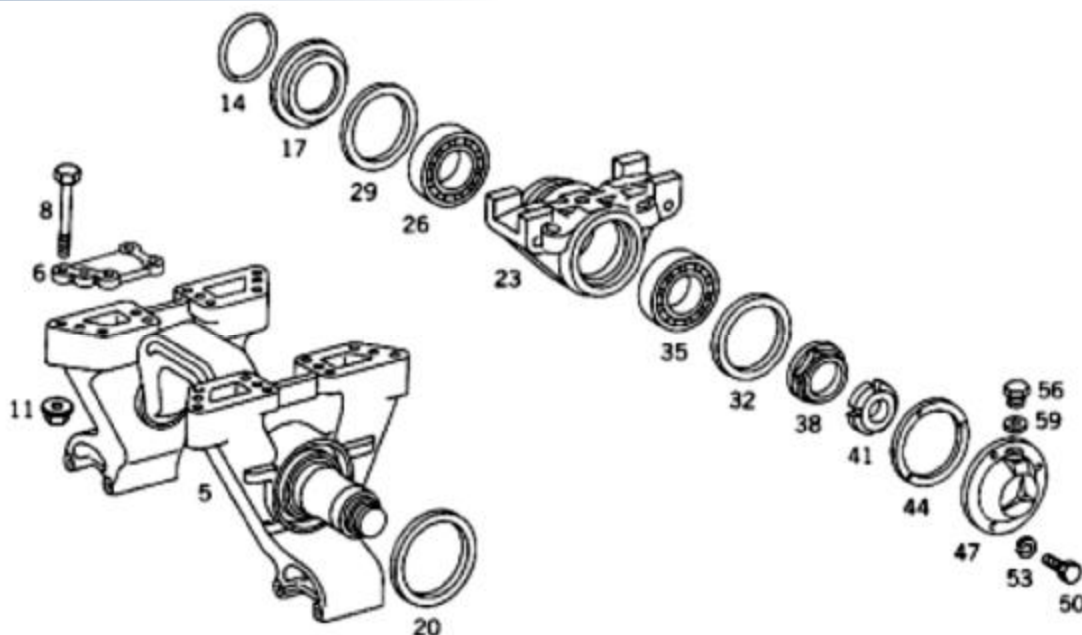
Ref. Salanguera	Ref. Or.	Descripción	Modelo	
BB-4014		Bulón ballesta Ø35 x 146	C-38 T	
BB-4016		Bulón ballesta Ø32 x 135	DG-209.26	
BB-4017		Bulón gemela Ø42 x 130	DG-290.26	
BB-4018		Bulón barra Ø48 x 116	DG-290.26	
BB-4019		Bulón palanca Ø52 x 151	DG-290.26	
BB-4022		Bulón ballesta Ø32 x 160	DG-290.26	
BB-4024		Bulón ballesta Ø30 x 135		

Ref. Salanguera	Ref. Or.	Descripción	Modelo	
BB-4025	5000540964	Bulón ballesta Ø25 x 130	MIDLINER S140	
BB-4025/1	5000351055	Bulón ballesta Ø22 x 125	MIDLINER S100	
BB-4026	5010130738	Bulón-Tornillo Con engrase Ø20x 160	AE-500 MAGNUM G MANAGER 4x2 MAXTER PREMIUM	
BB-4026/1	5010294415	Bulón-Tornillo Con engrase Ø20 x 170		
BB-4027	5010064632	Bulón palanca Ø28 x 146	GBH, TGH 280 GLM / TLM 280 CBH / CLM 280/340 MAXTER KERAX	
BB-4028	5000710567	Bulón ballesta Ø36 x 165		
BB-4028/1		Bulón ballesta Ø36 x 155 2chavetas		

Ref. Salanguera	Ref. Or.	Descripción	Modelo	
CAPUCHINOS:	CP-120801711	12 x 80	Diámetro: Ø12 Ancho cabeza: Ø17 Altura cabeza: 11mm	
	CP-121001711	12 x 100		
	CP-121201711	12 x 120		
	CP-121401711	12 x 140		
	CP-121601711	12 x 160		
	CP-121801711	12 x 180		
	CP-122001711	12 x 200		
	CP-122201711	12 x 220		
	CP-122401711	12 x 240		
	CP-122601711	12 x 260		
	CP-122801711	12 x 280		
	CP-123001711	12 x 300		
	CP-123201711	12 x 320		
CAPUCHINOS:	CP-140802211	14 x 80	Diámetro: Ø14 Ancho cabeza: Ø22 Altura cabeza: 11mm	
	CP-141002211	14 x 100		
	CP-141202211	14 x 120		
	CP-141402211	14 x 140		
	CP-141602211	14 x 160		
	CP-141802211	14 x 180		
	CP-142002211	14 x 200		
	CP-142202211	14 x 220		
	CP-142402211	14 x 240		
	CP-142602211	14 x 260		
	CP-142802211	14 x 280		
	CP-143002211	12 x 300		
	CAPUCHINOS:	CP-161202425		
CP-161402425		16 x 140		
CP-161602425		16 x 160		
CASQUILLOS :	CB-202660	Ø20 x Ø26 x 60		
	CB-253070	Ø25,4 x Ø30 x 70		
	CB-253270	Ø25,4 x Ø32 x 70		
	CB-283490	Ø28 x Ø34 x 90		
	CB-283590	Ø28 x Ø35 x 90		
	CB-304080	Ø30 x Ø40 x 90		
	CB-323690	Ø32 x Ø36 x 90		
	CB-323890	Ø32 x Ø38 x 90		
	CB-324090	Ø32 x Ø40 x 90		
	CB-354390	Ø35 x Ø43 x 90		
	CB-425242	Ø42 x Ø52 x 42		
	CB-657550	Ø65 x Ø75 x 50		
	CB-651104	Ø65 x Ø110 x 4		

Ref. Salanguera	Ref. Or.	Descripción	Modelo	
CB-2044104	5010060127	Casquillo acero-bronce Ø20 x Ø44,7 x 104	G MANAGER PREMIUM MAXTER MAGNUM PREMIUM KERAX	
13.11.1192	5010051192	Tapa casquillo Ø63 x 8		
CB-1637070	5000392206	Casquillo acero-nilón Ø16 x Ø37 x 70	B70 B90 B80 / 110 / 120 MASCOTT	
CB-1641077	8200024453	Casquillo goma Ø16 x Ø41 x 77	MATER	
CB-1441077				
R-MASTER.01	5010064837	Silleta balancín Abarcón varilla Ø24	KERAX AE MAGNUM 390 420 TI / 430 470 / 560	
R-MASTER.01.27	5010064735	Silleta balancín Abarcón varilla Ø27	CBH / CLM 280 / 340 MAXTER 6x4 8x4, KERAX	
R-MASTER.7257	7421087257	Silleta balancín Ø150 x 251/270 x 140	KERAX DXI 11 FAB-34.C/34.F KERAX DXI 13 FAB-36.D/36E	
		VOLVO: 21087257 20522482		
R-MASTER.9274	7420429274	Silleta balancín Ø135	KERAX DXI 11—FAB-34 PREMIUM TR PREMIUM PR KERAX SAMPT	
		VOLVO: 20429274		
R-MASTER.1785	0000551785	Arandela de ataque 0,5mm.	KERAX AE MAGNUM 390 420 TI / 430 470 / 560	
R-MASTER.1784	0000551784	Arandela de ataque 1mm.		



Ref. Salanguera	Ref. Or.	Descripción	Modelo	
R-MASTER.02	0024478010	Retén silleta Ø165 x Ø220 x 31	G MASTER 6x2, 6x4 G340TI 6X6 MAXTER 6X4. 6X8 KERAX MAGNUM E-TECH 400/440/480	
R-MASTER.23	5010064737	Semi-eje  Taladros Ø12mm. Corona agujeros Ø109 Longitud 389mm Diámetro ext. 105/106	CBH / CLM280 / 340 AE380 / 385TI / 420TI / 500 MAXTER 6x4, 8x4 G MANAGER 6x2, 6x4 KERAX AE MAGNUM 390	
R-MASTER.04	0000408526	Casquillo silleta Ø118 x Ø130 x 90	CBH / CLM280 / 340 AE380 / 385TI / 420TI / 500 MAXTER 6x4, 8x4 G MANAGER 6x2, 6x4 KERAX AE MAGNUM 390	
R-MASTER.05	5010229070	Tapa silleta Ø9/200 x 39	CBH / CLM280 / 340 AE380 / 385TI / 420TI / 500 MAXTER 6x4, 8x4 G MANAGER 6x2, 6x4 KERAX AE MAGNUM 390	
R-MASTER.06		Tapón tapa silleta		
R-MASTER.08	5003065168	Torica	CBH / CLM280 / 340 AE380 / 385TI / 420TI / 500 MAXTER 6x4, 8x4 G MANAGER 6x2, 6x4 KERAX AE MAGNUM 390	
R-MASTER.09	0000444899	Arandela amarre Del semieje Ø46 x Ø160 x 14	CBH / CLM280 / 340 AE380 / 385TI / 420TI / 500 MAXTER 6x4, 8x4 G MANAGER 6x2, 6x4 KERAX AE MAGNUM 390	
R-MASTER.09/1	06028158915	Tornillos semieje (6)		
R-MASTER.10	5010064738	Arandela reten Ø118,5 x Ø199 x 7	CBH / CLM280 / 340 AE380 / 385TI / 420TI / 500 MAXTER 6x4, 8x4 G MANAGER 6x2, 6x4 KERAX AE MAGNUM 390	

Ref. Salanguera	Ref. Or.	Descripción	Modelo	
R-MASTER.11	0000408558	Arandela ranurada Ø120 x Ø164 x 7	G MASTER 6x2, 6x4 G340TI 6X6 MAXTER 6X4. 6X8 KERAX MAGNUM E-TECH 400/440/480	
R-MASTER.8563	0000408563	Camisa cementada Ø105 x Ø118 x 214	G MASTER 6x2, 6x4 G340TI 6X6 MAXTER 6X4. 6X8 KERAX MAGNUM E-TECH 400/440/480	
R-KERAX.2252	7420442252  VOLVO: 20442252	Soporte Silent-bloc de apoyo silleta  Ø81/103 x Ø154/172 x 71	KERAX DXI 11 KERAX SAMPT PREMIUM –TR-FAB-24.F PREMIUM –PR-FAB-24.F	
R-KERAX.6804	7420466804  VOLVO: 20466804	Manguito soporte de Silleta Modelo antiguo  Ø25 x 107 x 74	KERAX DXI 11 KERAX SAMPT PREMIUM –TR-FAB-24.F PREMIUM –PR-FAB-24.F	
R-KERAX.3702	7421363702  VOLVO: 21178062 21363702	Manguito soporte de Silleta Modelo moderno  Ø25 x 105 x 67	KERAX DXI 11 KERAX DXI 13 KERAX 8x4 PREMIUM DXI 7 PREMIUM TR PREMIUM PR	
SB-164370	5010537365	Silent bloc ballesta Ø16 x Ø43,5 x 70	MASCOT FAB-52A MASCOTT DXI	
SB-165170	5010537367	Silent bloc ballesta Ø16 x Ø51 x 70	MASCOTT -FAB-52A MASCOTT DXI	

Ref. Salanguera	Ref. Or.	Descripción	Modelo	
SB-185170	5010537366	Silent bloc ballesta Ø18 x Ø51 x 70	MASCOTT -FAB-52A MASCOTT DXI	
SB-8082	5000448404	Silent bloc ballesta Ø16 x Ø43,5 x 95	M 140 / 160 / 200 / 230 MIDLINER MIDLUM	
SB-8082/1	5000448405  VOLVO: 20498774	Silent bloc ballesta Ø20 x Ø54 x 95	M 140 / 160 / 200 / 230 MIDLINER MIDLUM	
SB-8085	5010294961	Silent bloc ballesta Ø16 x Ø43 x 81	MIDLUM	
SB-8086	5010294770	Silent bloc ballesta Ø20 x Ø53,5 x 81	MIDLUM	
SB-215685	5010066115	Silent bloc ballesta Ø21 x Ø56,5 x 85	AE380 / 385TI / 420TI / 500 AE MAGNUM 390 / 420TI	
SB-256885	5010066116	Silent bloc ballesta Ø25 x Ø68,5 x 85	AE380 / 385TI / 420TI / 500 AE MAGNUM 390 / 420TI	

Ref. Salanguera	Ref. Or.	Descripción	Modelo	
SB-205096	5010630625 7421483476	Silent bloc ballesta Ø20 x Ø50 x 96	PREMIUM DXI 11 / 12 MIDLUM MAGNUM	
SB-246063	7482139627 5001867975	Silent bloc ballesta Ø24 x Ø60 x 63	MAGNUM DXI12 PREMIUM TR -FAB	
SB-164339	5010537282	Silent bloc ballesta Ø16,5 x Ø43 x 29/39	MASCOTT DXI-FAD 52A	
SB-3070098104	5001835446 5001852218  FRUEHAUF: M001502 SAF: 4177301000	Silent bloc ballesta Ø30 x Ø70 x 98 x 104	AE 380 / 385TI / 420TI / 500 PREMIUM TR 4x8 PREMIUM 6x2 , 6x4 AE MAGNUM 390 / 420TI PREMIUM PR 4X2 KERAX	
SB-8083/1	7420839455 7422187008 22187008  VOLVO: 20839455	Silent bloc ballesta Ø24 x Ø61,5 x 87	MAGNUM DX1 12 PREMIUM TR-PR FAB 27JC	
SB-8083	5001859721	Silent bloc ballesta Ø24 x Ø61,5 x 96	MAGNUM E-TECH 400 / 440 PREMIUM TR 4X2 PREMIUM TRACTEUR 4x2 KERAX	
SB-246296	7420929989 5010557698  VOLVO: 20929989 20592656	Silent bloc ballesta Ø24,3 x Ø62 x 96	MAGNUM DXI 12 FAB17 JD PREMIUM TR, PR KERAX DXI 11	







Ref. Salanguera	Ref. Or.	Descripción	Modelo	
SB-246195	5001874879 5010557875 5001874879  VOLVO: 20733583	Silent bloc ballesta Ø24 x Ø61,5 x 77 x 95	MAGNUM DXI 12-VAR-120AV PREMIUM DXI 11-FAB-27JC/ TC-27RC/SC	
SB-8081	5000731430  DAF: 0361478	Placa separación Ø85 x 17	PREMIUM TR 4x2 PREMIUM 6x2 MAXTER 4x2, 4X4 AE MAGNUM 390/420TI PREMIUM PR	
SB-8060/6	5000288447  MERCEDES: 66673250084	Placa separación 55 x 80,5 x 14	S110 / 130 S100 MIDLINER MACOTT	
SB-8111	5001832708  VOLVO: 1591299 1598391 1628397	Placa separación 90 x 100 x 11	PREMIUM R 1990 R1993 G 340TI, TR 18T	
SB-8088	5001834111	Placa separación 80 x 100 x 11	AE380 / 385TI / 500 / 520 G MANAGER 4x2 AE MAGNUM 390 KERAX PREMIUM	
SB-8060/1	5001853313	Placa separación M8x28/19 x 60 x 60	MIDLUM MIDLINER PREMIUM	
SB-8060/2	5001014359	Placa separación M8x28/19 x 65 x 80		
SB-8089	5001834501	Placa separación M8x32,5/22 x 80 x 86	PREMIUM	

Ref. Salanguera	Ref. Or.	Descripción	Modelo	
SB-8084	5010383950	Tope suspensión M12/Ø79,5 x 121	MAXTER KERAX	
SB-8113/3	7420390836  VOLVO: 1089501 1629553 20390836 8151413	Taco apoyo suspensión 151mm.	KERAX PREMIUM	
TA-24200260	7400984970  VOLVO: 993079	Tornillo acero 12.9 M24/200 x 260	KERAX DXI 11 KERAX SAMPT PREMIUM –TR-FAB-24.F PREMIUM –PR-FAB-24.F	
A-3011617	5010239047	Arandela escalonada Ø30,5 x Ø116,5 x 17  Adaptable: SB-3070098104	AE 380 / 385TI / 420TI / 500 PREMIUM TR 4x8 PREMIUM 6x2 , 6x4 AE MAGNUM 390 / 420TI PREMIUM PR 4X2 KERAX	
A-2410818	5010557138 Ballesta de 100 mm.	Arandela escalonada Ø24,5 x 108 x 18	MAGNUM E-TECH 400 / 440 PREMIUM TR 4x2 PREMIUM TRACTEUR 4x2 KERAX	
A-2410824	5010557979 Ballesta de 90 mm.	Arandela escalonada Ø24,5 x 108 x 24		
24.16.0451	5010383545 20500857	Silent-bloc barra estabilizadora Ø20 x Ø51,5 x 41	PREMIUM AE MAGNUM	
24.16.0452	5010304948	Casquillo barra estabilizadora Ø42 x Ø56 x 25	MAXTER KERAX	

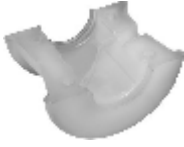
Ref. Salanguera	Ref. Or.	Descripción	Modelo	
24.16.0453	5010294991	Casquillo barra estabilizadora Ø30x Ø42 x 19	PREMIUM AE MAGNUM	
24.16.0454	7401135085	Casquillo barra estabilizadora Ø46x Ø28 x 25	KERAX PREMIUM	
	VOLVO: 1135085			
24.16.0455	5000393794	Casquillo barra estabilizadora Ø12x Ø27,5 x 21	B 70 B 90 B 80 / 110 / 120 MASCOTT	
24.16.0456	0000790899	Ø43 x Ø61 x 32	G MANAGER MAXTER	
24.16.0457	5010239670	Ø42 x Ø60,5 x 26	G 170 / 26 / 230 PREMIUM	
24.16.0458	5000719742	Ø29 x Ø44,5 x 28,5	MUGNUM GLC / GLR 190	
24.16.0459	0000754160	Ø30 x Ø45,5 x 31	TF 231 D	
24.16.0460	7401134955	Ø28 x Ø57,5 x 64	MIDLUM MIDLINER	
24.16.0461	5000434716	Ø20 x Ø45 x 66	MASCOTT KERAX	
24.16.0462	5516010769	Ø18 x Ø34 x 54	PREMIUM	
24.16.0392	5010304950	Casquillo barra estabilizadora Ø50,5 x Ø86 x 63	MAXTER KERAX	
	MERCEDES: 3873260181			
24.16.0465	5010557313	Ø50 x Ø64,5 x 76,5	G MANAGER MAXTER	
24.16.0466	5010557314	Ø38 x Ø64,5 x 76,5	KERAX MIDLUM	
24.16.0467	5010557315	Ø38,5 x Ø58,5 x 73		
24.16.0468	0000707791	Ø42,5 x Ø456 x 69		

Ref. Salanguera	Ref. Or.	Descripción	Modelo	
24.16.0469	5010557312	Ø55 x Ø64,5 x 76,5	MIDLUM G 260 / 290 / 210 / 230	
24.16.0470	5000725147	Ø44,5 x Ø59	MANAGER	
24.16.0471	5000352545	Ø32 x Ø42 x 80		
24.16.0472	5000279225	Ø38 x Ø58 x 74	R 310 4 x2 S 170, S 130, S 100	
24.16.0473	5000352492	Ø39,5 x Ø53,5 x 80	PJK / PJN / PJP JP 11 / 13	
24.16.0474	5000464786	Ø49 x Ø63,5 x 76		
24.16.0475	7420873195	Ø45,5 x 64,5 x 61,5 / 77		
24.16.0476	5010066937	Ø53 x Ø76 x 76	G MANAGER KERAX	
24.16.0477	5000464785	Ø54,6 x Ø64 x 76	AE 380 / 385 TI / 420 TI / 500 R 1990	
24.16.0478	5000714088	Ø25,5 x Ø44,5 x 49,5	AE MAGNUM MIDLUM PREMIUM	
24.16.0479	7401629169	Ø60 x 97	KERAX PREMIUM NIDLINER	
24.16.0480	5516031136	Ø34 x 70		
24.16.0481	5516031135	Ø40 x 80		
24.16.0482	5010215010	Ø35 x 80		
24.16.0488	5010130021	Ø38 x Ø67 x 60	PREMIUM AE MAGNUM	
24.16.0489	5010060356	Ø52 x Ø90 x 74	KERAX AE 380 / 385TI / 420TI / 500	
24.16.0490	5010130022	Ø41 x Ø67 x 60		
24.16.0491	5010130023	Ø33,5 x 67x 60		
24.16.0496	7420527057	Ø50 x 132 x 79,5	KERAX PREMIUM	
				
24.16.0497	5010066936	Ø41 x 84	AE 380 / 385TI / 420TI / 500 G 340TI PREMIUM AE MAGNUM	





Ref. Salanguera	Ref. Or.	Descripción	Modelo	
24.16.0498	0000716243	Ø38 x 63	TR / GR 305 GR / TR 280	
24.16.0499	0000716242	Ø41 x 63	R 310 R 360 GR 151 D	
24.16.0500	0000714814	Ø34 x 63	TR / GR 305 GR / TR 280	
24.16.0501	0000707792	Ø50 x 75	R 310 R 360 GR 151 D	
SOPR-0001	5010532578 5010533287 5010497133	Soporte ballesta  Delantero Ballesta trasera	KERAX CBH	
SOPR-0002	5010092421	Soporte ballesta  Ballesta delantera Parte derecha	KERAX	
SOPR-0003	5010092419	Soporte ballesta  Ballesta delantera Parte Izquierda	KERAX	
SOPR-0005	0000776875	Soporte ballesta  Delantero Ballesta trasera	KERAX CBH SERIES G	
SOPR-0006	5010239121 5010239120	Soporte ballesta  Delantero Ballesta trasera	PREMIUM	

Ref. Salanguera	Ref. Or.	Descripción	Modelo	
SOPR-0007	5010228282	Soporte resbalón  Trasero Ballesta trasera	PREMIUM	
SOPR-0008	5010228746 7482095208	Soporte resbalón  Ballesta trasera	MIDLUM	
SOPR-0009	5430121658	Soporte ballesta  Ballesta trasera Parte delantera	R-350	
SOPR-0010	5000731504 5600210215	Soporte ballesta  Trasero		
SOPR-0011	5010239228	Soporte gemela Izquierdo  Con casquillo: CB-2044104	PREMIUM	
SOPR-0012	5010239229	Soporte gemela Derecho  Con casquillo: CB-2044104	PREMIUM	
SOPR-0011/I	5010532925 7482421629	Soporte ballesta Ballesta delantera Parte trasera Izquierdo  Con silent-bloc: SB-246296	PREMIUM KERAX	

Ref. Salanguera	Ref. Or.	Descripción	Modelo	
SOPR-0012/D	5010532926 7482421696	Soporte ballesta Ballesta delantera Parte trasera Derecho con Silentbloc: SB-246296	PREMIUM KERAX	
SOPR-00023	5010460627 7482085991	Soporte Ballesta  Ballesta trasera Parte delantera	MIDLUM	
SOPR-0024	7482137342 7482137341 5010574557 7482441451	Soporte ballesta  16 Taladros	KERAX 440	
SOPR-0025	5010532882 5010532823 7482321489 5010574556	Soporte ballesta  14 Taladros	PREMIUM	
SOPR-0026	5010532528 7484099249 84099249	Soporte ballesta IZQUIERDO Modelo Corto Con silent-bloc: SB-246296	KERAX	
SOPR-0027	5010532768 7484099250 84099250	Soporte ballesta DERECHO Modelo corto Con silent-bloc: SB-246296	KERAX	
SOPR-0019	5010064658 5010562795	Soporte resbalón DD-TI	KERAX CBH	

Ref. Salanguera	Ref. Or.	Descripción	Modelo	
SOPR-0020	5010562794 5010064659	Soporte resbalón DI-TD	KERAX CBH	
GERE-0003	500075218	Ø24 x 110 c/c		
GERE-0005	5000751329	Ø20 x 95 c/c		
GERE-0006	5000752128	Ø20 x 120 c/c		
SB-246430	5010377448	Ø24 x Ø64 x 30	X108	
SOPR-0018	5000704835	Almohadilla asiento abarcón	KERAX CBH	
002806001	7420829503  VOLVO: 20829503 20392649 1629734	Tirante en V  L: 671mm. Tubo de: Ø58  Kit puntas: 100206001 Kit central: 100206006	KERAX	
100206001	7420840815  VOLVO: 20840815	Kit reparación puntas:  Bola: Ø85mm Taladro: Ø21mm Distancia Ø/Ø: 130mm Ancho: 30mm	KERAX	
100206002	7420840820  VOLVO: 20840820	Kit reparación central:  Bola: Ø90mm Cono: Ø45mm Largo: 60mm	KERAX	

Ref. Salanguera	Ref. Or.	Descripción	Modelo	
100206003	7420741703  VOLVO: 20367004 20507262 20741695	Tirante en V  L: 662,4mm. Tubo de: Ø50  Kit puntas: 100206004 Kit central: 100206006	KERAX PREMIU	
100206004	7420547286  VOLVO: 20547286 SCANIA: 1515981 MAN: 81432706119	Kit reparación puntas:  Bola: Ø75mm Taladro: Ø19mm Distancia Ø/Ø: 115mm Ancho: 24mm	KERAX PREMIUM	
100206006	7420741710  VOLVO: 20741710 3093544	Kit reparación central:  Bola: Ø72mm Cono: Ø38mm Largo: 46mm	KERAX PREMIUM	

## KERAX 420 TI (Abarcón de 24Ø y 27Ø)



FIGURA	O.R.	CANTIDAD	DESCRIPCIÓN	R. SALANGUERA
4	5010064737	1	Semieje	R-MASTER.23
6	0000408563	1	Camisa cementada Ø105*118*214	R-MASTER.8563
13	5010064837	1	Silleta balancín ( Abarcón de 24 Ø )	R-MASTER.01
14	0000408526	1	Casquillo silleta	R-MASTER.04
16	0000408558	2	Arandela ranurada	R-MASTER.11
17	5010064738	1	Arandela reten	R-MASTER.10
20	0000444899	1	Arandela amarre semieje	R-MASTER.09
21	0024478010	1	Reten silleta	R-MASTER.02
22	5003065168	2	Tòrica	R-MASTER.08
25	000551785	1	Arandela de ataque 0,5mm.	R-MASTER.1785
25	000551784	1	Arandela de ataque 1,0mm.	R-MASTER.1784
26	5010229070	1	Tapa silleta	R-MASTER.05
13	5010064735	1	Silleta balancín ( Abarcón de 27 Ø )	R-MASTER 01.27
29		1	Tapón tapa silleta	R-MASTER.06
23	06028158915	6	Tornillos semieje	R-MASTER.09/1

## KERAX-VOLVO

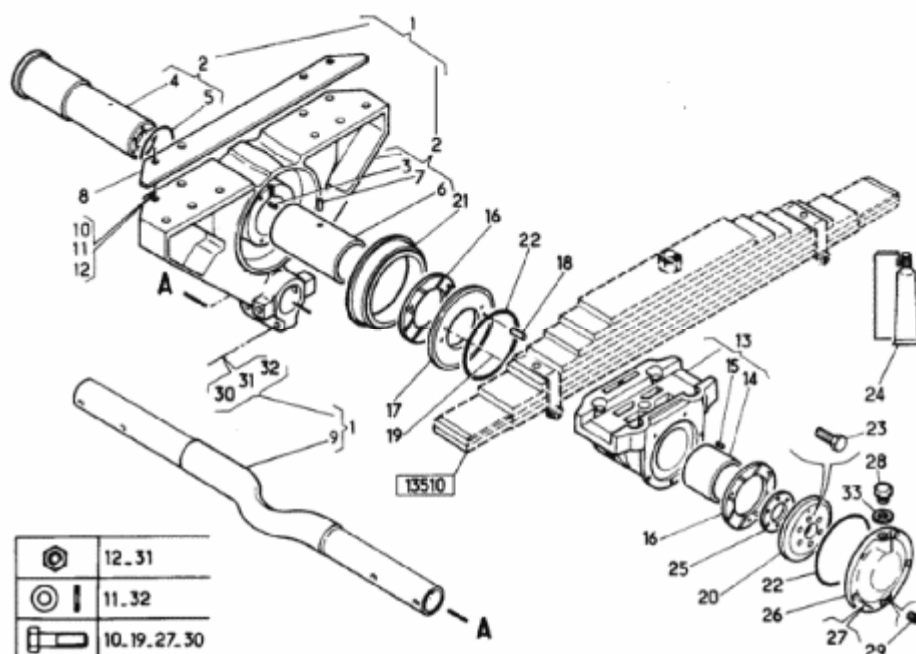

FIGURA	O.R.	CANTIDAD	DESCRIPCIÓN	R. SALANGUERA
2	7420442252 20442252	2	Soporte silent-bloc apoyo silleta	R-KERAX.2252 VOLVO.2252
3	7421087257 21087257	1	Silleta balancín	R-MASTER.7257 VOLVO.7257
4	7420466804 20466804	1	Manguito soporte silleta (antiguo)	R-KERAX.6804 VOLVO.6804
4	7421363702 21178062	1	Manguito soporte silleta (moderno)	R-KERAX.3702 VOLVO.8062

SCANIA

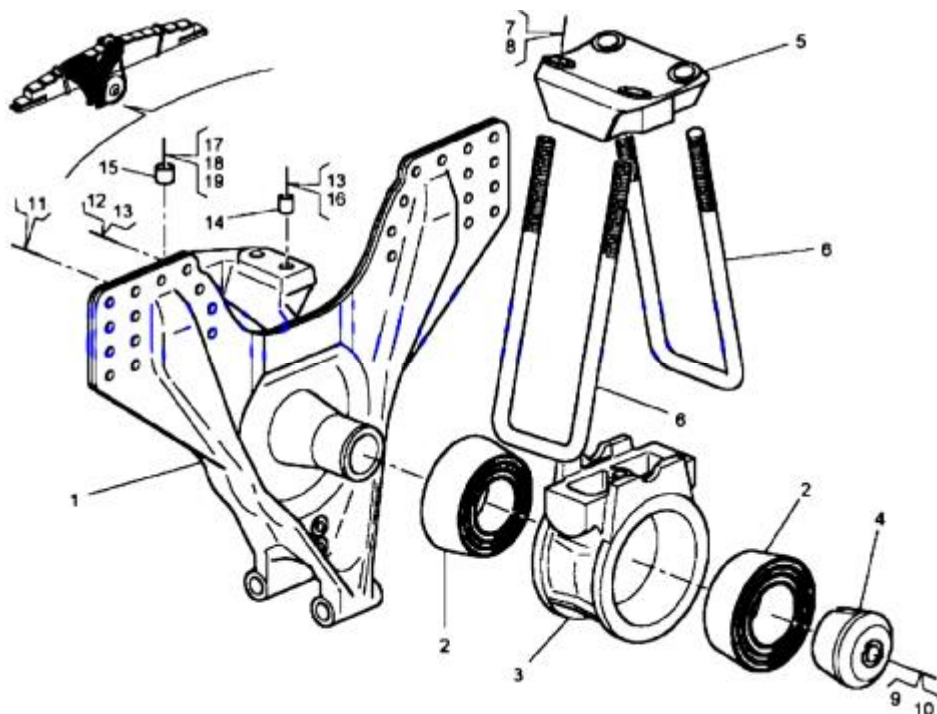

Ref. Salanguera	Ref. Or.	Descripción	Modelo	
BB-4161	0355145	Bulón ballesta delantera	Series 3	
	128681	Ballesta 90mm.	Series 4	
	2085822	Ø24 x M28/4 x 166	P, G, R, T	
BB-4162	128680	Casquillo roscado	Series 3	
		Ballesta delantera	Series 4	
		Ballesta de 90mm	P, G, R, T	
		M28/4 x 36,1 x 90		
BB-4163	0355147	Bulón ballesta trasera	Series 4	
	0135035	Ballesta 90mm.	P, G, R, T	
		Ø32 x M36/4 x 169		
BB-4164	0135036	Casquillo roscado	Series 4	
		Ballesta trasera	P, G, R, T	
		Ballesta de 90mm		
		M36/4 x 46 x 90		
BB-4165	0355148	Bulón ballesta trasera	Series 3	
	0202333	Ballesta 100mm.	Series 4	
		Ø32 x M36/4 x 181	P, G, R, T	
BB-4166	0135698	Casquillo roscado	Series 3	
		Ballesta trasera	Series 4	
		100mm	P, G, R, T	
		M36/4 x 46 x 102		
BB-4167	01364140	Bulón ballesta trasera	Series 4	
		Cabeza 56mm.	P, G, R, T	
		Ø32 x M36/4 x 170		

Ref. Salanguera	Ref. Or.	Descripción	Modelo	
BB-4161TORICA	0182929	Torica bulón Ballesta delantera  Ø23 x 6	Series 3 Series 4 P, G, R, T	
BB-4164TORICA	0182931	Torica bulón Ballesta trasera  Ø31,5 x 6,5	Series 3 Series 4 P, G, R, T	
SB-3065117122	0255669	Silent-bloc ballesta  Ø30 x Ø65 x 117 x 122	93 Serie 113 Serie 124 Serie 143 Serie 144	
SB-3065106122	1362710 445589	Silent-bloc ballesta  Ø30 x Ø65 x 106 x 122	Series 3 Series 4	
A-301056	0272449	Arandela lisa Adaptable: SB-3065117122  Ø30 x Ø105 x 6	93 Serie 113 Serie 124 Serie 143 Serie 144	
A-3010716	1117830 1367370	Arandela escalonada Adaptable: SB-3065106122  Ø30 x Ø107 x 16	Series 3 Series 4	
24.16.0550	213604	Casquillo barra estabilizadora  Ø40 x 65	Series 3 Series 4 P, G, R, T	

Ref. Salanguera	Ref. Or.	Descripción	Modelo	
24.16.0551	228483 / 1880751	Ø50 x 77	Series 3	
24.16.0552	1344190 / 1535026	Ø65 x 95	Series 4 P, G, R, T	
24.16.0553	295751	Ø49,5 x 93		
24.16.0558	1772693 1725213	Ø85 x Ø121 x 92	P, G, R, T	
SOSC-0001	0283642	Soporte Ballesta  Ballesta trasera Parte delantera Ø47 x 206 x 232 x 169	SERIES 3	
SOSC-0002	0275460	Soporte ballesta Ballesta delantera 164 x 174 x 221	P, G, R, T Series 3	
SOSC-0003	0202335 1377728	Soporte ballesta Ballesta trasera  330 x 460 x 170	P, G, R, T Series 3 Series 4	
SOSC-0004	1739455	Delantero Derecho	P, G, R, T Series 4	
SOSC-0005	1739454	Delantero Izquierdo		
SOSC-0009	1377779	Soporte Ballesta  Ballesta trasera Parte delantera Ø56 x 206 x 232 x 169	P, G, R, T F, K, N Series 3 Series 4	

Ref. Salanguera	Ref. Or.	Descripción	Modelo	
SOSC-0007	1744210	Rotula articulada	Series 4	
	1364293	Amortiguador de cabina	P, G, R, T	
	1443114			
	1504160	Ø16 x Ø54 x 81		
SOSC-0008	1744211	Rotula articulada	Series 4	
	1426202	Amortiguador de cabina		
		Ø16 x 121		
SOSC-0012	1725915	Soporte ballesta	Series 4	
	1325808	Ballesta delantera	P, G, R, T	
	1493210	Parte delantera		
SOSC-0013	1377745	Soporte Ballesta	Series 4	
		2º eje sus. Neumática	P, G, R, T Series 3	
SOSC-0014	1335902	Soporte ballesta	Series 4	
		Parte derecha		
		150 x 271 x 162		
SOSC-0015	1335901	Soporte ballesta	Series 4	
		Parte izquierda		
		150 x 271 x 162		
GES-0001	1377739	Gemela ballesta	Series 4	
	1103026	Ballesta delantera	P, G, R, T Series 3	
		67 x 154 x 153		

Ref. Salanguera	Ref. Or.	Descripción	Modelo	
GES-0002	363770 1377741	Gemela ballesta Ballesta trasera	P, G, R, T F, K, N SERIES 3 SERIES 4	
GES-0003	1377729	Gemela trasera Eje estabilizador  Ø62 X 170 X 240 X 108	P, G, R, T SERIES 3 SERIES 4	
GES-0004	552004	KIT reparación gemela GES-0003	P, G, R, T SERIES 3 SERIES 4	
SB-1528208	1528208	Placa punta ballesta Ballesta delantera 80 x 110 x 11,5 (42 c/c)	P 84, P 114, P 124, P 164	
002906001	1440028 1722582	Tirante en V L: 613,2mm. Tubo de: Ø46  Kit puntas: Kit central:	SERIES: G-P-R-T	
002906002	1444472	Kit reparación puntas:  Bola: Ø70mm Taladro: Ø19mm Distancia Ø/Ø: 115mm Ancho: 24mm	SERIES: G-P-R-T	
002906001	1722584 S  MAN: 81432706134	Kit reparación central:  Bola: Ø85mm Taladro: Ø25mm Distancia Ø/Ø: 152mm Ancho: 24mm	SERIES: G-P-R-T	

Ref. Salanguera	Ref. Or.	Descripción	Modelo	
002904013	1382236	Silleta balancín	Series 3	
	1388783	Ballesta de 90mm.	Series 4	
		Ø110 x Ø140		
002904014	1118446	Arandela de fricción	Series 3	
	204731	Ballesta de 90mm. y Ballesta de 100mm.	Series 4	
		Ø112 x Ø134 x 2,5		
002904015	1390097	Retén silleta	Series 3	
	1431199	Ballesta de 90mm.	Series 4	
	1380324			
	1357942			
		Ø140 x Ø170,5 x 17,5		
002904016	1380325	Arandela de cierre	Series 3	
	217303	Ballesta de 90mm.	Series 4	
		Ø12,5 x Ø82/Ø135 x 13		
002904017	1379697	Tapa silleta	Series 3	
	193988	Ballesta de 90mm.	Series 4	
		Ø10,5x158/Ø178x48,5		
002904018	1399489	Silleta balancín	Series 4	
	1404352		P- G- R- T-	
		M145 x 2/Ø110 x Ø140		
002904010	1474065	Arandela de fricción	Series 4	
			P- G- R- T-	
		Ø111 x Ø137 x 2,5		

Ref. Salanguera	Ref. Or.	Descripción	Modelo	
002904012	204737	Arandela fijación Series 4 y ballesta 100mm  Ø95 x Ø134 x 10	Series 3 Series 4 P- G- R- T-	
002904009	204723	Arandela fijación Series 4 y ballesta 100mm  Ø95 x Ø130 x 2	Series 3 Series 4 P- G- R- T-	
002904005	1343178 204724	Tuerca de eje  Series 4 y ballesta 100mm  M95 x 2	Series 3 Series 4 P- G- R- T-	
002904006	1383063	Tapa silleta   M145 x 2/72	Series 4 P- G- R- T-	
002904007	1754546 1799423 204733 378277	Casquillo de silleta Series 4 y Ballesta de 100mm.  Ø110 x Ø115,5 x 80	Serie 3 Series 4 P- G- R- T-	
002904004	1386105	Junta tórica   Ø153 x Ø165,5 x 10	Series 4 P- G- R- T-	
002904002	1386104	Anillo de desgaste   Ø162,5 x Ø190 x 13	Series 4 P- G- R- T-	

Ref. Salanguera	Ref. Or.	Descripción	Modelo	
002904011	1367303	Porta retén Ø115,5 x Ø140 x 28	Series 4 P- G- R- T-	
002904003	1386227	Retén Ø140 x Ø170 x 15	Series 4 P- G- R- T-	
002904019	204732 1379964	Silleta balancín Ballesta de 100mm. Ø115,5	Series 3 Series 4	
002904020	204746	Casquillo Ballesta de 100mm. Ø132 X 38	Series 3 Series 4	
002904021	204735	Arandela 0,25mm Ballesta de 100mm.	Series 3 Series 4	
002904022	204750	Junta de tapa silleta Ballesta de 100mm. Ø144,5 x Ø184 x 1	Series 3 Series 4	
002904023	1378337 204738	Tapa de silleta Ballesta de 100mm. Ø9 x 164/Ø175,5 x 40	Series 3 Series 4	



Ref. Salanguera	Ref. Or.	Descripción	Modelo	
002904024	204728	Retén silleta Ballesta de 100.  Ø141 x Ø196 x 24	Series 3 Series 4	
002904025	804721	Junta torica Ballesta de 100mm. Ø109,5 x 3	Series 3 Series 4	
002904030	804727	Junta tórica Ballesta 90mm. Ø140x3		
002904026	204727	Espaciador porta reten Ballesta de 100mm.  Ø8,5xØ174/Ø193,5x23	Series 3 Series 4	
002904027	204719	Arandela cónica apriete Ballesta de 100mm.  Ø107 x Ø122 x 25	Series 3 Series 4	
002904028	204722	Arandela distanciadora Ballesta de 100mm.  Ø95 x Ø125 x 10	Series 3 Series 4	
002904029	252497	Semieje Ballesta de 100mm.  M95 x 2/Ø110 x 520	Series 3 Series 4	
002904001	1949551 1874825 1422961	Silleta balancín  Ø110	Series 4 Series P Series G Series R Series T	



FIGURA	O.R.	CANTIDAD	DESCRIPCIÓN	R. SALANGUERA
2	1382236	1	Silleta balancín	002904014
3	1754546	2	Casquillo silleta	002904007
4	1431199	1	Reten silleta	002904015
5	1118446	2	Arandela de fricción	002904014
6	804727	1	Junta torica	002904030
7	1380325	1	Arandela de cierre	002904016
10	1379697	1	Tapa de silleta	002904017



FIGURA	O.R.	CANTIDAD	DESCRIPCIÓN	R. SALANGUERA
6	1399489 1404352	1	Silleta balancín	002904000
6	1949551 1874825 1422961	1	Silleta balancín	002904001
7	1383063	1	Tapa silleta	002904006
8	1343178	1	Tuerca de eje	002904005
9	204723	1	Arandela fijación	002904009
10	204737	1	Arandela fijación	002904012
11	1474065	2	Arandela de fricción	002904010
12	1386227	2	Reten	002904003
13	1386104	1	Anillo de desgaste	002904002
14	1386105	1	Junta torica	002904004
15	1367303	1	Porta reten	002904011
17	1754546	2	Casquillo de silleta	002904007
18	804690	1	Torica tapa silleta	002904008
16	806312	1	Engrasador	EB-2
4	1422970	2	Tapa semieje	
5	1422971	1	Arandela semieje	

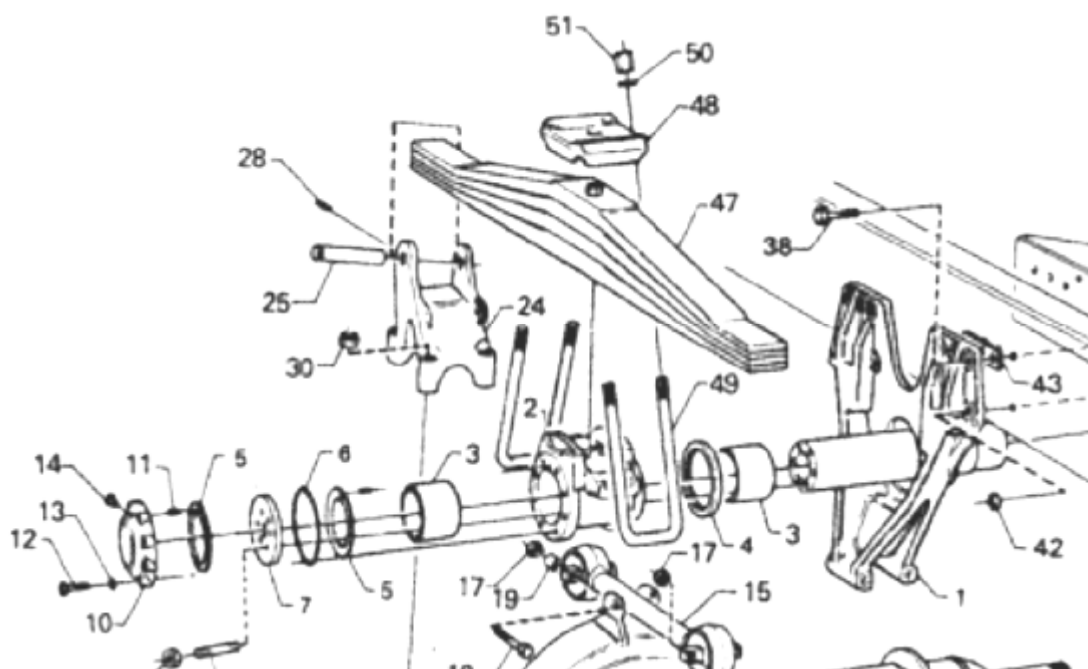

FIGURA	O.R.	CANTIDAD	DESCRIPCIÓN	R. SALANGUERA
21	204719	2	Arandela cónica apriete	002904027
22	252497	1	Semieje	002904029
23	204722	1	Arandela distanciadora	002904028
24-38	204723	1	Arandela de fijación	002904009
25-39	1343178	1	Tuerca de semieje	002904005
26	204727	1	Espaciador porta reten	002904026
28	804721	1	Junta torica	002904025
29-35	1118446	2	Arandela de fricción	002904014
30	204728	1	Reten silleta	002904024
31	204732	1	Silleta balancín	002904019
32	204746	1	Casquillo	002904020
33	1754546	2	Casquillo de silleta	002904007
36	204735	1	Arandela 0,25mm.	002904021
37	204737	1	Arandela fijación	002904012
40	1378337	1	Tapa de silleta	002904023
41	204750	1	Junta tapa silleta	002904022

**VOLVO**

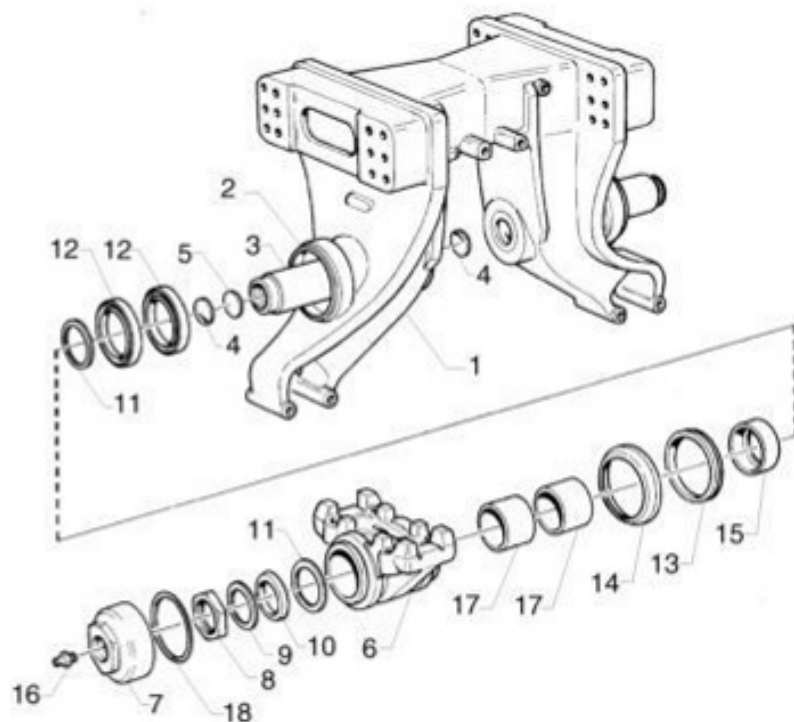
Ref. Salanguera	Ref. Or.	Descripción	Modelo	
BB-4181/1	1075723	Bulón ballesta Engrase por cabeza  M33/400 x Ø30 x 173	FH 12, FH 16, FM 10, FM 12, FM 7 FM 9	
BB-4183/1	1076334	Bulón ballesta Engrase por chaveta  M33/400 x Ø30 x 173	FH 12, FH 16, FM 10, FM 12, FM 7 FM 9	
BB-4182/1	1075726 85134672 20526026 1075724	Casquillo ballesta Con retenes  M33/400 x 45 x 104	FH 12, FH 16, FM 10, FM 12, FM 7 FM 9	
BB-4181	1614229 339465	Bulón ballesta delantera Cabeza con ranura Engrase por chaveta  M35/300 x 167	F 10, F 12, F 6 FL 10, FL 12, FL 7	
BB-4183	1614230 1589024	Bulón ballesta delantera Cabeza con taladros Engrase por cabeza  M35/300 x 169	F 10, F 12, F 6 FL 10, FL 12, FL 7	
BB-4182	0310947	Casquillo ballesta Rosca interior  M35/300 x 45 x 100	F 10, F 12, F 6 FL 10, FL 12, FL 7	
BB-4184	1598764 1576943	Bulón ballesta c/t Delantero Ballesta trasera  M24/300 x Ø25 x 165	F 10, F 12, F 16 FL 10, FL 12, FL 7	

Ref. Salanguera	Ref. Or.	Descripción	Modelo	
BB-4187	1598766 1622502	Bulón ballesta c/t Trasero Ballesta trasera  M24/300 x Ø25 x 175	F 10, F 12, F 16, FH 12, FH 16, FL 10, FL 12, FL 7 FM 10, FM 12, FM 7, FM 9 NH 12	
BB-4185	1608019 1598761	Casquillo ballesta Rosca exterior  M45/300 x Ø25 x 109	F 10, F 12, F 16, FH 12, FH 16, FL 10, FL 12, FL 7 FM 10, FM 12, FM 7, FM 9 NH 12	
BB-4186	1598721	Casquillo ballesta Rosca interior  M45/300 x Ø55 x 104	F 10, F 12, F 16, FH 12, FH 16, FL 10, FL 12, FL 7 FM 10, FM 12, FM 7, FM 9 NH 12	
BB-4188	1598765	Bulón gemela c/t  M24/300 x Ø25 x 220	F 10, F 12, F 16 FL 10, FL 12, FL 7	
BB-4189	1608018 1598762	Casquillo gemela Rosca exterior  M45/300 x Ø25 x 152	F 10, F 12, F 16 FL 10, FL 12, FL 7	
BB-4192		Bulón doble dirección		
BB-4193		Casquillo bronce Ø30		
BB-4194		Casquillo bronce Ø38		
BB-4182	0310947	Casquillo rosca interior		
BB-4195	6776803	Bulón ballesta Ballesta delantera  M35/300 x Ø25 x 80/140	FL 6 FL 608-6015 SERIES FLC	

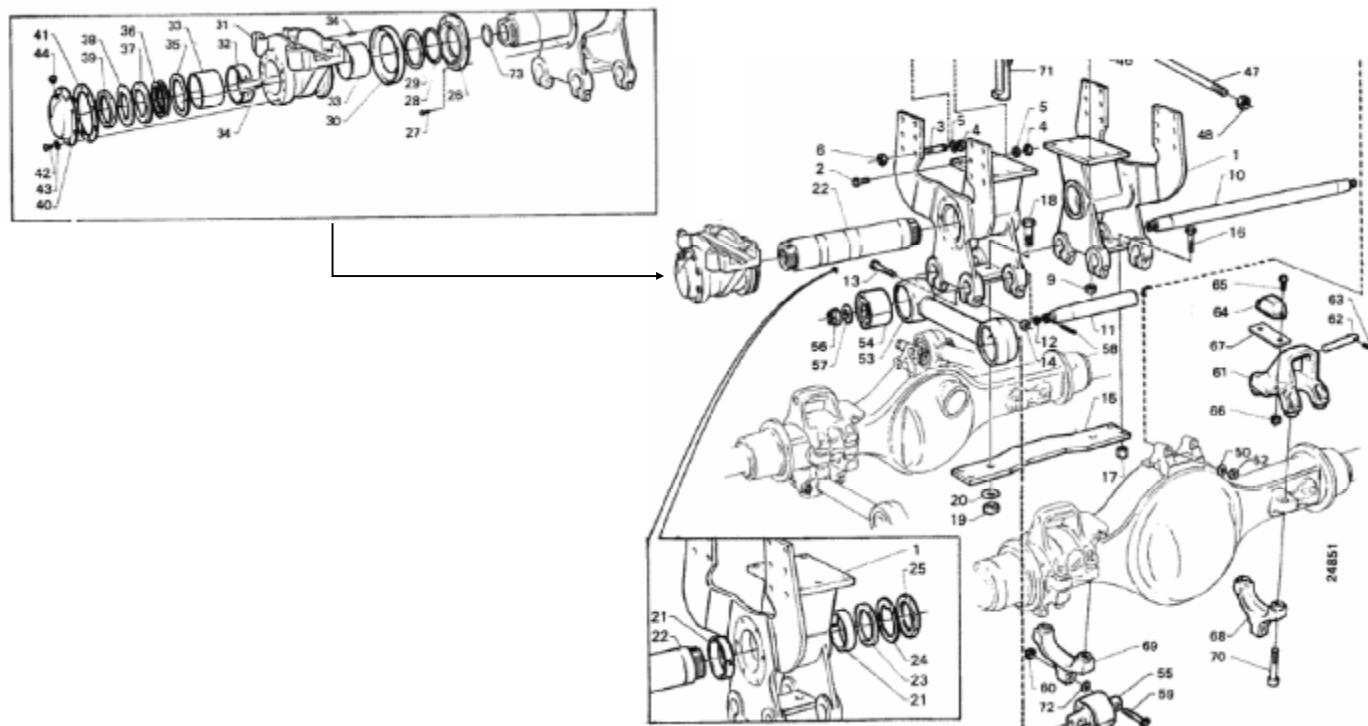
Ref. Salanguera	Ref. Or.	Descripción	Modelo	
BB-4195/1	6795567	Bulón ballesta Ballesta delantera  M35/300 x Ø25 x 95/160	FL 6 FL 616-619 SERIES FLC	
BB-4196	6776801	Casquillo ballesta Rosca interior  M35/300 x Ø45 x 80	FL 6 FL 616-619 SERIES FLC	
BB-4197	6776804	Bulón ballesta c/t Ballesta de 80mm.  M20/250 x Ø20 x 125	FL 6 FL 608-615 SERIES FLC	
BB-4198	6776802	Casquillo ballesta Rosca exterior  M36/300 x Ø20 x 92	FL 6 FL 616-619 SERIES FLC	
BB-4190	1626577	Bulón pasante  M24/300 x Ø26 x 200	FH 12 BR NH 12 BR NH 12 FH 12 J FH 16 J	
BB-4199	363910 1609960	Bulón ballesta Excéntrico  M35/300 x 210	F 10, F12, F 6, FH 12, FH 16 FL 10, FL 12, FL 6, FL 7 FM 10, FM 12, FM 7, FM 9 N 10 NL 10 S NL 12 S	
BB-4197/1	6795968	Bulón ballesta c/t Ballesta de 100mm.  M20/250 x Ø20 x 160	FL 6 FL 626-619 FS 7	



Ref. Salanguera	Ref. Or.	Descripción	Modelo	
BB-4197/2	6782621	Casquillo ballesta Rosca exterior  M35/300 x Ø20 x 112	FL 6 FL 608-615 SERIES FLC	
BB-4197/3	6781880	Casquillo ballesta Rosca interior  M35/300 x Ø50 x 104	FL 6 FL 608-615 SERIES FLC	
BB-4195/2	6781881	Bulón ballesta Caras planas  M35/300 x Ø25 x 170/95	FL 6 FL 616-619 FS 7	
BB-4195/3	6777141	Bulón ballesta Caras planas  M35/300 x Ø25 x 150/80	FL 6 FL 608-615 FL 616-619 FS 7 SERIES FLC	
BB-4181/2	20427987	Bulón ballesta  M33/400 x 201	FH 12 FH 6 FM 12 FM 9	
CAPUCHINOS:	CP-122002255 CP-122202255	12 x 200 12 x 220	Diámetro: Ø12 Ancho cabeza: Ø22 Altura cabeza: 55mm	
SB-8111	1628397 1591299 1598391	Placa separación  90 x 100 x 11	F 10, F 12, FL 10, FL 12, FL 6 FL 616-619	
	R.V.I.: 5010832708			

Ref. Salanguera	Ref. Or.	Descripción	Modelo	
SB-8111/1	1626139	Placa separación 85 x 140 x 11/16	F 10, F12, F16 FH 12, FH 16 FM 7, FM 9, FM 10, FM 12 FS 7 FL 6, FL 10, FL 12	
SB-8112	6775502	Placa separación 70 x 80 x 11	FL 6 FL 608-615 FL 616-619	
SB-8112/1		Placa separación 70 x 100 x 11	FS 7	
072587	1582587	Rodillo de BOGGIE: Ø30x98x100	Rueda trasera suspensión BOGGIE. Con Bulón	
SB-8115		Tornillo Allen DIN 7984 8 X 25		
SB-8118	1580214	Tope suspensión M12/175 X 75/52	F 10, F 12, F 16, FL 10, FL 12, FL 7 FM 12, FM 9 N 10, N 12	
SB-8119	1628449	Tope suspensión Ø96 x 92	FH 12 FH 16 FL 608-615 FM 10 FM 12 FM 7 FM 9	
SB-8119/1	1506399 354149  R.V.I.: 7401506399	Tope suspensión Ø96 x 118	B 7, B7 F, B 7 R F 10, F 12, F 16, FH 12, FH 16 FL 10, FL 12, FL 6, FL 7 FM 10, FM 12, FM 7	

Ref. Salanguera	Ref. Or.	Descripción	Modelo	
SB-8116	3027227	Silent-bloc ballesta  Ø20 x Ø55,5 x 120	FL 6 FL 616-619	
SB-8053	6879332  MAN: 81960200231 81960200250 81960200252	Silent-bloc ballesta  Ø16 x Ø50 x 95	FL 6 FL 608-615 SERIES FLC	
SB-8113/3	1089501 1629553 20390836 8151413 R.V.I.: 7420390836	Taco apoyo suspensión  151mm.	F 10 FH 12, FH 16, FL 10, FL 12, FL 7 FM 10, FM 12, FM 7 N 10, N 12 NH 12	
SB-2655105112	1624486	Silent-bloc ballesta  Ø26 x Ø55 x 105 x 112	F 10, F 12, F 16, FH 12, FH 16 FM 7, FM 9, FM 10, FM 12 FS 7 SERIES FLC FL 6, FL 10, FL 12	
SB-2459107	1696042  SAF: 4177000800	Silent-bloc ballesta  Ø24 x Ø59 x 107	F 10 F 12	
SB-8083/1	20839455  R.V.I.: 7420836455	Silent-bloc ballesta  Ø24 x Ø61,5 x 87	SERIES FE	
SB-1640100120	0363862	Silent-bloc ballesta  Ø16 x Ø40 x 100 x 120	F 10, F12, F 16 FL 10, FL 12, FL 7 N 10, N 12	

Ref. Salanguera	Ref. Or.	Descripción	Modelo	
SB-205295110	20533294	Silent-bloc ballesta Ø20,5 x Ø52 x 95 x 110	F 10, F12, F16, FH 12, FH 12 J, FH 16 FM 7, FM 9, FM 10, FM 12 FL 6, FL 10, FL 12 SERIES FLC	
SB-205295110 S	20533294 S1	Silent-bloc ballesta Ø20,5 x Ø51 x 95 x 110	F 10, F12, F16, FH 12, FH 12 J, FH 16 FM 7, FM 9, FM 10, FM 12 FL 6, FL 10, FL 12 SERIES FLC	
SB-8054	6771007	Silent-bloc PIN Ø45,5 x 80/151	FL 6 FL 608-615	
SB-8054/1	6772290	Silent-bloc PIN Ø45,5 x 100/171	FL 6 FL 608-615	
SB-8055	6850876	Silent-bloc PIN Ø45,5 x 100/161	FL 6 FL 608-615	
SB-8055/1	6850875	Silent-bloc PIN Ø45,5 x 80/140	FL 6 FL 608-615 SERIES FLC	
SB-8056	6850874	Silent-bloc PIN Ø40,5 x 70/130		

Ref. Salanguera	Ref. Or.	Descripción	Modelo	
SB-8124	343348	Silent-bloc PIN  Ø51 x 89/167		
SB-8057	1501677	Silent-bloc PIN  Ø51 x 100/178,5	F 10, F 12, F 16 FL 10, FL 12, FL 7 N 10, N12	
SB-1111	3111274 85104649	Silent-bloc ballesta  Ø13 x Ø60,5 x 73	B 10 B LE B 12 B B 10 L B 12 B B 6 B LE B 7 L, B 7 L DD, B 7 R	
SB-1112	3112049 70308561	Silent-bloc ballesta  Ø16 x Ø70 x 82,5	B 10 L B 12 B B 6 B LE B 7 L B 7 L DD B 7 R	
24.16.0600	1134955  IVECO: 99432757 R.V.I.: 7401134955	Silent bloc barra estabilizadora  Ø28 x Ø57,5 x 64	FH 12, FH 16 FM 10, FM 12, FM 7, FM 9 B 12, B7	
24.16.0601	1620750	Ø34x Ø65,5 x 64	B 7 R B 7 R BR	
24.16.0602	1624605	Ø17 x Ø45 x 50	F 10, F 12, F 16 FH 12, FH 16 FL 10, FL 12, FL 6, FL 7 FM 10, FM 12, FM 7, FM 9	
24.16.0605	3028449	Ø55x Ø78 x 96	FH 12, FH 16	
24.16.0606	9516524	Ø53 x Ø80 x 95	FM 10, FM 7, FM 9, FM 12 NH 12 FL 10, FL 12, FL 7	

Ref. Salanguera	Ref. Or.	Descripción	Modelo	
24.16.0607	9519245	Ø59x Ø90 x 95	FH 12, FH 16, FH 10	
24.16.0608	9959304 / 9516523	Ø59 x Ø90 x 95	FL 10, FL 12, FL 7 FM 10, FM 12, FM 9, FM 7 NH 12 B 10 B, B 10 M, B 12	
24.16.0611	1079256	Ø42x Ø80 x 95	FH 12, FH 16	
24.16.0612	1077594	Ø72 x Ø116 x 95	FM 10, FM 12, FM 9, FM 7 NH 12	
24.16.0613	3173991	Ø47 x Ø75 x 70	FL 6	
24.16.0614	20428165	Ø30x Ø61 x 55	FH 12, FH 16	
24.16.0615	20428166	Ø35,5 x Ø61 x 55	FM 16, FM 12, FM 9 NH 12	
24.16.0616	20428167	Ø41,5 x Ø61 x 55		
24.16.0617	3173993	Ø55x Ø74 x 70	FH 12, FH 16,	
24.16.0618	1079225	Ø58 x Ø103,5 x 78	FM 9, FM 12 FL 6	
24.16.0619	20493701	Ø53 x Ø103,5 x 78	FH 12, FH 16	
24.16.0620	20452330	Ø64 x Ø107 x 65	FL 6, FM 12, FM 9, FM 7	
24.16.0622	1580010	Ø49x Ø90 x 86	F 10, F 12, F 16,	
24.16.0623	1580009	Ø30 x Ø66 x 75	FL 10, FL 12, FL 7	
24.16.0454	1135085	Casquillo barra estabilizadora Ø16 x Ø28 x 25	FH 12, FH 16 FM 10, FM 12, FM 7, FM 9 FS 7 FL 10, FL 12, FL 6, FL 7 NH 12	
	R.V.I.: 7401135085			

Ref. Salanguera	Ref. Or.	Descripción	Modelo	
24.16.0625	1589807	Ø25 x Ø35 x 23	F 10, F 12, F 16, FL 10, FL 6, FL 12, FL 7	
24.16.0626	1587261	Ø25 x Ø35 x 27		
24.16.0627	6799335	Ø25,5 x Ø49,5 x 23,5	FL 6 SERIES FCL FL 608-615 FL 616-619	
24.16.0628	0605047	Ø61 x Ø75 x 96	F 10, F 12, F 6	
24.16.0630	1622838	Ø75 x Ø95 x 96	FH 12, FH 16, FL 10, FL 12, FL 7	
24.16.0631	6875470	Ø43 x Ø61 x 69	FM 10	
24.16.0632	0605182	Ø55 x Ø73 x 95	F 10, F 12, F 6	
24.16.0633	6799680	Ø69,5 x Ø90 x 89	FH 12, FH 16, FL 10, FL 12, FL 7	
24.16.0634	6771515	Ø45 x Ø60 x 70,5	FM 10	
24.16.0635	1607561	Ø65 x Ø74 x 96	F 10, F 12, F 16 FH 12, FH 16 FL 10, FL 12, FL 6, FL 7	
24.16.0636	1628318	Ø53 x Ø70 x 91	FH 12, FH 16, FL 6 FM 10, FM 7 FS 7	
24.16.0637	1611551	Ø40x 59	F 10, F 12, F 16	
24.16.0638	1624611	Ø35 x 59	FL 10, FL 12, FL 6, FL 7 FS 7	
24.16.0639	6772312 / 6856049	Ø40 x 56,5	N 10, N 12 FH 12, FH 16	

Ref. Salanguera	Ref. Or.	Descripción	Modelo	
24.16.0640	1075180	Ø45 x 66	FH 12, FH 16	
24.16.0641	1075179	Ø35 x 67	FM 10, FM 12, FM 7, FM 9 NH 12	
24.16.0642	1076890	Ø40 x 66		
24.16.0643	1075187	Ø52 x 96	FH 12, FH 16	
24.16.0644	1075188	Ø59,6 x Ø74 x 96	FM 10, FM 12, FM 7, FM 9 NH 12	
24.16.0645	1575339	Ø49 x 93,5	F 10, F 12, F 16	
24.16.0646	1609768	Ø53 x 75	FL 10, FL 12, FL 7	
24.16.0647	1973032	Ø50 x 75		
24.16.0648	1629169	Ø60 x 97	F 10, F 12, F 16	
24.16.0649	363864	Ø45 x 75	FL 10, FL 12, FL 7	
SOPV-0001	1598824	Soporte ballesta Delantero Ballesta trasera h: 178	F 10, F 12, F 16 FL 10, FL 12, FL 7	
SOPV-0002	363889	Soporte ballesta Bulón descentrado	F 12	
SOPV-0003	1619857	Soporte ballesta Delantero Ballesta trasera	F 12	



Ref. Salanguera	Ref. Or.	Descripción	Modelo		
SOPV-0004	1590744	Soporte ballesta	N 12		
	1530744	Trasero Ballesta delantera 6 Taladros	NL 12 F 10 F 12		
SOPV-0005	1605815	Soporte ballesta	FL 10		
		Trasero Ballesta delantera 8 Taladros			
SOPV-0006	1613279	Soporte ballesta	FL 7		
		Delantero Ballesta delantera	FL 10 FL 12		
SOPV-0007	8162242	Soporte ballesta	FL 10		
		Delantero Trasera izquierda			
SOPV-0008	1611534	Soporte ballesta	FL 10		
	1625779	Delantero Trasera derecha			
SOPV-0010	363806	Soporte ballesta	N 10		
	1065278	Delantero Delantoro derecha	NL 10 NL 12		
SOPV-0011	1624481	Soporte amortiguados	F 12		
			N 12		
			NL 10		

Ref. Salanguera	Ref. Or.	Descripción	Modelo	
GEV-0003	20548421 1619860 3171036	Gemela ballesta Ballesta delantera	FH 12, FH 16 FM 10, FM 12 FM 7, FM 9	
GEV-0001	1590360	Gemela ballesta Ballesta delantera	F 12 N 12 NL 12	
GEV-0002	1068840	Gemela ballesta Ballesta trasera		
GEV-0009	20467735	140 x 50 x 21 Pasante	FH 12	
GEV-0010	20882212	140 x 50 x 20 Roscada	FH 6 FM 12	
TA-20155	20883938 20467714	M20x2,5 /155mm.	FM 9 NH 12	
GEV- 0004	6772604	Kit semi-gemela	FL 6	
GEV-0005	1070700	Semi-gemela pasante Ø20mm.	FL 6	
GEV-0006	6771382	Ø16mm.	FL 6	
GEV-0007	6790829	Ø20 x 85		
GEV-0008	6793672	Ø20 x 100		

Ref. Salanguera	Ref. Or.	Descripción	Modelo	
002806011	8156991 20556490 3173291 1628133	Tirante en V  L: 677mm. Tubo de: Ø60 Kit puntas: 002806002 Kit central: 002806003	FH 12	
002806002	1628107	Kit reparación puntas:  Bola: Ø91mm Taladro: Ø15mm Distancia Ø/Ø: 145mm Ancho: 26mm	FH 12	
002806003	3173759 1075255 1591689 20554908	Kit reparación central:  Bola: Ø138mm Taladro: Ø15mm Distancia Ø/Ø: 95mm	FH 12	
002806004	1094466 20382314 20502944	Tirante en V  L: 649mm. Tubo de: Ø48  Kit puntas: 100206005 Kit central: 100206006	FL 12 FL 6 FM 12	
002806005	3092452	Kit reparación puntas:  Bola: Ø75mm Taladro Ø17/20mm Distancia Ø/Ø: 115mm Ancho: 24mm	FL 12 FL 6 FM 12	
100206006	20741710 3093544  R.V.I.: 7420741710	Kit reparación central:  Bola: Ø72mm Cono: Ø38mm Largo: 46mm	FL 12 FL 6 FM 12	
100206003	20367004 20741703 20507262 20741695  R.V.I.: 7420741703	Tirante en V  L: 663mm. Tubo de: Ø50 Kit puntas: 100206005 Kit central: 100206006	FE 240-26 FE 280-26 FH 12 FH 16 FM 400, 480, 520 FL 6 FM 12, FM 7, FM 9	

Ref. Salanguera	Ref. Or.	Descripción	Modelo	
100206004	20547286  R.V.I.: 7420547286	Kit reparación puntas: Bola: Ø75mm Taladro: Ø19mm Distancia Ø/Ø: 115mm Ancho: 24mm	FE 240-26 FE 280-26 FH 12, FH 16 FM 400, 480, 520 FM 12, FM 7, FM 9	
100206006	20741710  R.V.I.: 7420741710	Kit reparación central:  Bola: Ø72mm Cono: Ø38mm Largo: 46mm	FE 240-26 FE 280-26 FH 12, FH 16 FM 400, 480, 520 FM 12, FM 7, FM 9	
002806007	1080690 1606200 1576952 1509222 6886777	Tirante en V  L: 636mm. Tubo de: Ø58  Kit puntas: 100306007 Kit central: 100306008	F10, F12, F16 FL 10, FL 12 N 10, N12	
100306007	274056 276192 6889513 DAF: 0696321 SCANIA: 1104336	Kit reparación puntas:  Bola: Ø95mm Taladro Ø23mm Distancia Ø/Ø: 152mm Ancho: 35mm.	F10, F12, F16 FL 10, FL 12 N 10, N12	
100306008	273706 276191  DAF: 0696320 MAN: 81432706080	Kit reparación central:  Bola: Ø72mm Cono: Ø38mm Largo: 46mm	F10, F12, F16 FL 10, FL 12 N 10, N12	
002806008	3172829 8073569	Tirante en V  L: 677mm. Tubo de: Ø50  Kit puntas: 002806009 Kit central: 002806010	F 12 FL 6 NH 12	
002806009	3092452 3090452	Kit reparación puntas:  Bola: Ø75mm Taladro Ø17mm Distancia Ø/Ø: 115mm Ancho: 20mm.	F 12 FL 6 NH 12	

Ref. Salanguera	Ref. Or.	Descripción	Modelo	
002806010	2271188	Kit reparación central:  Bola: Ø72mm Cono: Ø38mm Largo: 46mm	F 12 FL 6 NH 12	
002806001	1076639 1626896 1629734 2039264 20829503  R.V.I.: 7420829503	Tirante en V  L: 671mm. Tubo de: Ø58  Kit puntas: 100206001 Kit central: 100206006	FH 12 FH 16 FL 6 FM 12 FM 9 NH 12	
100206001	20840815  R.V.I.: 7420840815	Kit reparación puntas:  Bola: Ø85mm Taladro: Ø21mm Distancia Ø/Ø: 130mm Ancho: 30mm	FH 12 FH 16 FL 6 FM 12 FM 9 NH 12	
100206006	20840820  R.V.I.: 7420840815	Kit reparación central:  Bola: Ø90mm Cono: Ø45mm Largo: 60mm	FH 12 FH 16 FL 6 FM 12 FM 9 NH 12	

Ref. Salanguera	Ref. Or.	Descripción	Modelo	
CB-2450110	20945984	Casquillo ballesta Metálico Ø24,5 x Ø50,6 x 110	F 10, F 12, F 16 FE 7 FH 12, FH 16 FL 6, FL 7, FL 10 FM 7, FM 9, FM 10, FM 12 N 10, N 12 NH 12	
CB-2451110	20959115	Casquillo ballesta Metálico Ø24,5 x Ø51,3 x 110	F 10, F 12, F 16 FE 7 FH 12, FH 16 FL 6, FL 7, FL 10 FM 7, FM 9, FM 10, FM 12 N 10, N 12 NH 12	
SB-246195	20733583  RVI: 5001874879 5010557875 5001874879	Silent bloc ballesta Ø24 x Ø61,5 x 77 x 95	SERIES FH SERIES FM SERIES FE	
SB-246296	20929989 20592656  RVI: 7420929989 5010557698	Silent bloc ballesta Ø24,3 x Ø62 x 96		
TA-20223	20467715 21620168	Tornillo ballesta del. M20x2,5/223mm.	FM9, FM12, FH12, FH13, FH16, FMX	
TA-20155	20467714 20883938	Tornillo ballesta del. M20x2,5/155mm.		

FORD

Ref. Salanguera	Ref. Or.	Descripción	Modelo	
001713004	79VB5781CB  78VB5781DA 6052013	Silent-bloc ballesta  Ø20 x Ø46 x 61 x 66	FORD TRANSIT	
001713005	RVT5781AA	Silent-bloc ballesta  Ø19 x Ø38 x 61 x 67	FORD TRANSIT 900	
001713006	78VB5781CB 78VB5719CB 6054238	Silent-bloc ballesta  Ø16 x Ø46 x 60 x 82	FORD TRANSIT 900 TRANSIT 80 MD	
001713007	76VB5781AA 1575577	Silent-bloc ballesta  Ø18 x Ø37 x 60 x 66	FORD TRANSIT 91	
001713008	78VB5781AA	Silent-bloc ballesta  Ø18 x Ø46 x 61 x 67	FORD TRANSIT 78 MD	
001713003	92VB5781AA 95VB5781AA 6197149 7328510	Silent-bloc ballesta  Ø18 x Ø57 x 60 x 72	FORD TRANSIT 15	
001713009	92VB5719AA 6197146	Silent-bloc ballesta  Ø16 x Ø50 x 60 x 82	FORD TRANSIT 15	



Ref. Salanguera	Ref. Or.	Descripción	Modelo	
001713010	80VB5A546AA 6102898	Silent-bloc ballesta  Ø16 x Ø46 x 65 x 75	FORD TRANSIT 15	
001713001	YC155719AA	Silent-bloc ballesta  Ø14 x Ø50 x 60 x 68	FORD TRANSIT V184	
001713002	YC155781BB YC155781AC 4055743	Silent-bloc ballesta  Ø16 x Ø57 x 60 x 72	FORD TRANSIT V184 TRANSIT M12-15	
001713011	1575045	Silent-bloc ballesta  Ø16 x Ø46 x 60 x 67	FORD TRANSIT	
001713012	4023510	Casquillo de goma Ballesta trasera  Ø18,3 x 32 x 37	RANGER (MAGDA)	

ISUZU

Ref. Salanguera	Ref. Or.	Descripción	Modelo	
101513003	8942343190	Casquillo goma Ballesta trasera Parte trasera  Ø18,5 x 30 x 38	ISUZU KBD 25-26	
101513004	8491133232	Casquillo goma Ballesta trasera  Ø22 x Ø40 x 45 x 37	ISUZU NHR 88HP	
101513005	8491133142 8970815310	Casquillo goma Ballesta delantera  Ø22 x Ø40 x 40 x 32	ISUZU NKR NHR	
101513006	9841133143	Casquillo goma Ballesta trasera  Ø21 x Ø39 x 37 x 30	ISUZU 545, 110	
101513001	4894130354002 4897074826002	Silent-bloc ballesta Ballesta trasera  Ø16 x Ø42 x 72 x 82	ISUZU NPR	
101513002	4897074826002	Silent-bloc ballesta Ballesta trasera  Ø18 x Ø42 x 72 x 82	ISUZU 100 P	

## LAND ROVER

Ref. Salanguera	Ref. Or.	Descripción	Modelo	
CAPUCHINOS:	CP-080641211	8 x 64	Diámetro: Ø8	
	CP-080801211	8 x 80	Ancho cabeza: Ø12 Altura cabeza: 11mm	
SB-8041	233573	Silent-bloc ballesta  Ø14,3 x Ø30,2 x 63 x 70	SANTANA SERIES 3	
SB-8042		Silent-bloc chasis  Corto  Ø14 x Ø30,2 x 35 x 46		
SB-8043	569746	Silent-bloc chasis  largo  Ø14,2 x Ø30,2 x 86 x 92	SANTANA SERIES 2, 2 A, 3 SERIES 109	
SB-8044	569746	Silent-bloc chasis  Cazorla  Ø14,3 x Ø38 x 86 x 92		
SB-8041/1	PS-510000	Silent-bloc ballesta  ANIBAL  Ø14,3 x Ø36 x 63 x 70	ANIBAL	

**mitsubishi**







Ref. Salanguera	Ref. Or.	Descripción	Modelo	
SB-1628/3641	MB 584530	Casquillo goma Ø16 x Ø27,5 / 36 x 43	L-200 L-300 L-400 PAJERO 86	
SB-1627/4856	MB 111071	Casquillo goma Ø16 x Ø27,5 / 47,5 x 56	L-300 MONTERO	
SB-1832/3641	MB 111203	Casquillo goma Ø18 x Ø32 / 36 x 41	PAJERO	
SB-2340/3745 101513004	MB 025153	Casquillo goma Ø23 x Ø40 / 37 x 45	FUSO CANTER	
001813002	MR 158925	Silent-bloc ballesta Ø14 x Ø36 x 70 x 79	L 200	
001813003	MR 151808	Silent-bloc ballesta Ø14 x Ø40 x 70 x 79	L 200 L 300	
SB-14557080	55147 43002	Silent-bloc ballesta Ø14 x Ø55 x 70 x 80	L 400	

Ref. Salanguera	Ref. Or.	Descripción	Modelo
001813001		Silent bloc ballesta Ovalado  Ø14 x D72/55 x 79 x 69	L 300
		Silent-bloc ballesta  Ø14 x Ø36 x 60 x 70	





NISSAN

Ref. Salanguera	Ref. Or.	Descripción	Modelo	
BB-4042		Bulón gemela Ø19,5 x 142		
BB-4048		Bulón ballesta Ø24 x 145	L 80	
CAPUCHINOS:	CP-100801614 CP-101001614 CP-101201614	10 x 80 10 x 100 10 x 120	Diámetro: Ø10 Ancho cabeza: Ø16 Altura cabeza: 14mm	
CAPUCHINOS:	CP-121001616	12 x 100	Diámetro: Ø12 Ancho cabeza: Ø16 Altura cabeza: 16mm	
CB-192557	CASQUILLOS BALLESTA	Ø19 x Ø25,4 x 57		
CB-253263		Ø25,4 x Ø32 x 63		
CB-192225		Ø19 x Ø22,2 x 25,4		
CB-2530100		Ø25 x Ø30 x 100		
CB-2532100		Ø25 x Ø32 x 100		
CB-192563		Ø19 x Ø25 x 63		
CB-162570		Ø16 x Ø25 x 70		
CB-253070		Ø25 x Ø30 x 70		
101313002	55046-G8300	Ø14 x Ø28 x 39	VANETTE	

Ref. Salanguera	Ref. Or.	Descripción	Modelo	
101313001	55046-01G00	Casquillo de goma Ballesta trasera GEMELA  Ø20 x Ø32 x 37	NISSAN PICK-UP	
SB-8023	55046-G9106	Casquillo de goma  Trasera  Ø18 x Ø32 x 37	PATROL	
SB-8024	55045-G9600	Casquillo de goma  Delantera  Ø18 x Ø40 x 38	PATROL	
SB-8025	55046-G9600	Casquillo de goma  Gemela  Ø18 x Ø33 x 50	PATROL	
SB-8029	0411005-0	Silent-bloc ballesta  Ø16 x Ø42 x 70 x 76	NISSAN	
SB-8030	041.002.29-0	Silent-bloc ballesta  Ø20 x Ø45 x 80 x 92	NISSAN L 80	
SB-8031	4200.318-0	Silent-bloc ballesta  Ø24 x Ø45 x 65 x 77		

Ref. Salanguera	Ref. Or.	Descripción	Modelo	
SB-8032	142.003.69-1	Silent-bloc ballesta Ø24 x Ø48 x 80 x 92	NISSAN	
SB-8028	55045 07200 G9500	Silent-bloc ballesta Ø15,8 x Ø33 x 60 x 64	PATROL	
SB-8028/1	54560 01G00	Silent-bloc ballesta Ø18 x Ø40 x 60 x 70	PICK-UP	
SB-16457076		Silent-bloc ballesta Ø16 x Ø45 x 70 x 76	CABSTAR	
SB-14406070		Silent-bloc ballesta del. Ø14 x Ø40 x 60 x 70	NISSAN NAVARA	
SB-8026		Placa separación Ø50 (Tetón 10 x 8)	NISSAN	
SB-8026/1		Placa separación Ø60 (Tetón 14 x 6)		
SB-8027		Placa separación 50 x 50	PATROL	

Ref. Salanguera	Ref. Or.	Descripción	Modelo	
SB-8033		Placa hierro-goma Soporte ballestín  M8/125 x 80x 100		
SB-8034		Placa hierro-goma Soporte ballestín  M8/125 x 80x 100		
SB-8035 CT		Placa separación  M8/125 x 50 x 85 x 22	CABSTAR ATLEÓN	
NISSAN-00001		Soporte ballestín Agujeros bajo teja  Teja de 105mm.		
NISSAN-00002		Soporte ballestín Agujeros bajo teja  Teja de 105mm.		
NISSAN-00003		Kit soportes ballestín CABSTAR	CABSTAR	
NISSAN-00003/1		Kit soportes ballestín CABSTAR PESADA		
NISSAN-00008		Soporte ballestín Agujeros entre teja  Teja de 135mm.		

Ref. Salanguera	Ref. Or.	Descripción	Modelo	
NISSAN-00009		Soporte ballestín Agujeros bajo teja  Teja de 135mm.		
NISSAN-00010		Soporte ballestín Agujeros sobre teja  Teja de 135mm.		
NISSAN-00011		Soporte ballestín Agujeros sobre teja  Teja de 105mm.		
NISSAN-00012		Soporte ballestín Agujeros bajo teja  Teja de 120mm.		
NISSAN-00013		Soporte ballestín Agujeros sobre teja  Teja de 120mm.		
NISSAN-00014		Soporte ballestín Agujeros bajo teja  Teja de 105mm.		
NISSAN-00015		Soporte ballestín Regulable	CABSTAR ATLEON	
NISSAN-00015/1		Tope goma		

Ref. Salanguera	Ref. Or.	Descripción	Modelo	
NISSAN-00006		Gemela plana Completa  90mm. c/c	PATROL	
NISSAN-00007		Gemela curva Completa	PATROL	
NISSAN-		Gemela acodada corta Completa  90mm.		
NISSAN-		Gemela acodada larga Completa  150mm.		
NISSAN-00006/1		Bulón gemela Ø16 x 110		
NISSAN-00006/2		Bulón gemela Ø18 x 110		
NISSAN-00007/1		Bulón gemela Ø18 x 139		
NISSAN-00007/2		Bulón gemela Ø18 x 112		
NISSAN-00008		Gemela plana larga Delantera  140mm.	PATROL	

SUZUKI



Ref. Salanguera	Ref. Or.	Descripción	Modelo	
001913002	413331-82021 413331-62020	Casquillo goma Ballesta trasera Parte delantera  Ø16 x Ø40 x 33 x 25	VITARA SAMURAI SJ 410 ST 20	
001913001	09305-13002	Casquillo goma Ballesta trasera Parte trasera  Ø13 x Ø30 x 32 x 25	VITARA SAMURAI SJ 410 ST 20	
001913003	09319-12023	Silent-blocs ballesta  Ballesta trasera  Ø12 x Ø40 x 50 x 65	VITARA SANTANA SJ 413	
001913004	004-A5	Silent-blocs ballesta  Ballesta trasera  Ø12 x Ø46 x 50 x 64		

TOYOTA

Ref. Salanguera	Ref. Or.	Descripción	Modelo	
SB-8002	90385-18046	Casquillo goma Ballesta trasera Parte trasera  Ø17,5 x 30 x 37	RUNNER HILUX	
101513003	90385-18048	Casquillo goma  Ø17 x Ø29 x 37 x 30		
SB-8001	2198238587681	Casquillo goma  Ø17 x Ø35 x 41 x 33	CANDY	
SB-8004		Casquillo goma  Ø18 x Ø29 x 41 x 34		
SB-8005	90385-23037	Casquillo goma Ballesta trasera Parte trasera  Ø23 x Ø40 x 44 x 36	DYNA BU 15, BU 30, BU 84 BJ 40 RU 85, RU 221	
SB-8006	90385-16003 90389-16002 90389-16003	Silent-blocs ballesta  Ballesta trasera  Ø16 x Ø40 x 70 x 76	DYNA	
SB-14406066	903891-14007	Silent-blocs ballesta  Ø14 x Ø40 x 60 x 70		

# Suministros Salanguera

BPW

Ref. Salanguera	Ref. Or.	Descripción	Modelo	
BPDA-01	0529100010	Balancín  Silent-bloc Ø50 interior SP-9021	DAF BPW TRABOSA	
BPIE-03	2613270	Balancín  Silent-bloc Ø60 interior SP-9022	INTA EIMAR	
BPLC-04		Balancín  Silent-bloc Ø50 interior SP-9021	3 Ejes LECITRAILER	
BPLC-04 PAMPLONA	5140641	Balancín  Modelo PAMPLONA	LECITRAILER	
BP-5001	0317716250	Bulón balancín C/T Ø50 x 230  Tuerca: M42/300		
BP-5002	0317716290	Bulón balancín C/T Ø60 x 250  Tuerca: M42/300		
BP-24200170	Bulón c/t	Ø24 x 170		
BP-24200190	Bulón c/t	Ø24 x 190		

Ref. Salanguera	Ref. Or.	Descripción	Modelo	
BP-30350140	Bulón c/t	Ø30 x 140		
BP-30350150	Bulón c/t	Ø30 x 150		
BP-30350160	Bulón c/t	Ø30 x 160		
BP-30350170	Bulón c/t	Ø30 x 170		
BP-30350190	Bulón c/t	Ø30 x 190		
BP-30350200	Bulón c/t	Ø30 x 200		
BP-30350210	Bulón c/t	Ø30 x 210		
BP-30350220	Bulón c/t	Ø30 x 220		
BP-30350230	Bulón c/t	Ø30 x 230		
BP-30350240	Bulón c/t	Ø30 x 240		
BP-30350250	Bulón c/t	Ø30 x 250		
BP-30350260	Bulón c/t	Ø30 x 260		
BP-30350270	Bulón c/t	Ø30 x 270		
BP-30350290	Bulón c/t	Ø30 x 290		
BP-30350200KIT	0334105040	Bulón c/t Ballesta de 100mm. Ø30/M300 x 200	BPW AL-I	
BP-30350170KIT	0334105050	Bulón c/t Ballesta de 70mm. Ø30/M300 x 170	BPW AL-II	
BP-24200166KIT	0334014200	Bulón c/t Ballesta de 70mm. Ø24/M200 x 166 / Ø56	BPW AL-II	

Ref. Salanguera	Ref. Or.	Descripción	Modelo	
BP-BPW PLACA	0318120080	Casquillo de alineación  Ø30,5 x 50/59 x 20,5	BPW	
BP-BPW PLACA 100	0328154140	Placa de alineación  31 x 70,5 x 104 x 8	BPW AL-I	
BP-BPW PLACA PEQ	0328154180	Placa de alineación  31 x 57,5 x 104 x 8	BPW AL-II	
BP-BPW144250	0328144250	Placa de alineación Bulón Ø24 98 x 51,5 x 6		
BP-BPW154200	0328154200	Placa de alineación Bulón Ø24 86 x 65 x 8		
BP-BPW31626	0332034510	Arandela Ø31 x Ø62 x 5		
BP-BPW31554	0332032380	Arandela Ø31 x Ø55 x 4		
BP-BPW25606	0332033280	Arandela  Ø25 x Ø60 x 6		

Ref. Salanguera	Ref. Or.	Descripción	Modelo	
SOBPW-0028	0316435010	Placa desgaste Lisa Ø30	BPW	
SOBPW-0028/2	0316435020	Placa desgaste Troquelada Ø30	BPW	
SOBPW-0028/1	0316435040	Placa desgaste Lisa Ø24	BPW	
SOBPW-0028/3	0316435030	Placa desgaste Troquelada Ø24	BPW	
SOBPW-0027	0328125040	Placa inferior soporte Suspensión neumática	BPW	
SOBPW-0030	0518913190	Soporte elevador eje	BPW	
ARBPW-301205		Arandela Ballesta  Ø20 x Ø120 x 5	BPW	



Ref. Salanguera	Ref. Or.	Descripción	Modelo	
SOBPW-0020	0311302060	Casquillo ranurado Soporte s/n LT 30,3 x 54,7 x 24	LECITRAILER	
SOBPW-0026	0311323010	Casquillo ovalado Bulón Ø30 30,3/42,5 x Ø73,7 x 24	BPW AL-II Ballesta de 70mm. Ballesta de 100mm.	
SOBPW-303100	0311303100	Casquillo soldable Bulón Ø24 24,5/36,5 x Ø67,5 x 22	BPW	
SOBPW-0020/1	0320034050	Casquillo soldable Bulón Ø30 30,3 x Ø49,7 x 29,5	BPW VB - C VBT - C	
SOBPW-300501	0311300501	Casquillo soporte Bulón Ø24 24,5/36 x Ø90/Ø55x20	BPW AL - II	
SOBPW-301431	0311301431	Casquillo soporte Bulón Ø30 30,2/42 x Ø90/Ø55x20	BPW AL - II	
SOBPW-301370	0311301370	Casquillo soporte Elevador bilateral Bulón Ø30 Ø30 x 42/62 x 22	BPW	

Ref. Salanguera	Ref. Or.	Descripción	Modelo	
SOBPW-300510	0311300510	Casquillo soporte Elevador bilateral  Bulón Ø24 Ø24 x 42/62 x 22	BPW	
SOBPW-304110	0311304110	Casquillo nylon  Ø41 x Ø50 x 23	BPW	
SOBPW-301460	0311301460	Casquillo con alojamiento  Ø30,5 x Ø73,5 x 24	Series H ( SN 42..) Series K ( SN 36..) Series N ( SN 30..) Series SH ( SB 4345) Series H.LL ( SN 42..)	
SOBPW-0025	0300114860	Placa soldable alineación	BPW	
SOBPW-0025/1		Marco de centrado  90 x 72 x 12	BPW	
SOBPW-0025/2	0329546210	Marco de centrado  73 x 56 x 8	BPW	
SOBPW-0008	0334523090	Almohadilla asiento  Ancho de 130mm.	BPW ABARCÓN TIPO " BF "	

Ref. Salanguera	Ref. Or.	Descripción	Modelo	
SOBPW-0008/2	0334523021	Almohadilla asiento Ancho de 130mm.	BPW ABARCÓN TIPO " B "	
SOBPW-0008/1	0334521010	Almohadilla asiento Ancho de 100mm.	BPW ABARCÓN TIPO " B "	
SOBPW-0009		Almohadilla asiento Eje de 120mm.	BPW	
SOBPW-0010		Almohadilla asiento Eje de 150mm.	BPW	
SOBPW-0012	0503221180	Soporte asiento ballesta Derecho Ballesta de 70mm.	BPW AL - II SB 3745 SB 4345 SB 4309	
SOBPW-0013	0503221190	Soporte asiento ballesta Izquierdo Ballesta de 70mm.	BPW AL - II SB 3745 SB 4345 SB 4309	
SOBPW-2390D	0314522390	Soporte asiento ballesta Derecho	BPW	

Ref. Salanguera	Ref. Or.	Descripción	Modelo	
SOBPW-2390I	0314522390	Soporte asiento ballesta Izquierdo	BPW	
SOBPW-6940D	0103226930	Soporte asiento ballesta Derecho	BPW	
SOBPW-6940I	0103226940	Soporte asiento ballesta Izquierdo	BPW	
SOBPW-26460D	0503226460	Soporte asiento ballesta Derecho	BPW AL - I Eje de tambor	
SOBPW-26450I	0503226450	Soporte asiento ballesta Izquierdo	BPW AL - I Eje de tambor	
SOBPW-26500D	0503226500	Soporte asiento ballesta Derecho	BPW AL - I Eje de disco	
SOBPW-26490I	0503226490	Soporte asiento ballesta Izquierdo	BPW AL - I Eje de disco	





Ref. Salanguera	Ref. Or.	Descripción	Modelo	
SOBPW-0001		Soporte alojamiento del tensor  Eje de 120mm.	BPW LECITRAILER	
SOBPW-0002		Soporte alojamiento del tensor  Eje de 150mm.	BPW LECITRAILER	
SOBPW-0003		Soporte central Suspensión mecánica	BPW	
SOBPW-0004		Soporte trasero Suspensión mecánica	BPW	
SOBPW-0005		Soporte delantero Parte Derecha  Suspensión mecánica	BPW	
SOBPW-0006		Soporte delantero Parte Izquierda  Suspensión mecánica	BPW	
SOBPW-0007		Soporte central	BPW	

Ref. Salanguera	Ref. Or.	Descripción	Modelo	
SOBPW-40538	0537540538	Soporte ballesta	BPW AL - I	
SOBPW-44220	0537544220	Soporte ballesta Bulón de Ø24	BPW AL - II	
SOBPW-40538	0537540538	Soporte ballesta Bulón de Ø30	BPW AL - II	
<b>CAPUCHINOS:</b>	CP-160802411 CP-161202411 CP-161402411 CP-161602411 CP-161802411 CP-182002411 CP-162202411	16 x 80 16 x 120 16 x 140 16 x 160 16 x 180 16 x 200 16 x 220	Diámetro: Ø16 Ancho cabeza: Ø24 Altura cabeza: 11mm.	
SP-9021	0203166500 0203160500	Silent-bloc balancín  Goma-metal Ø50 x Ø100,5 x 130	VB-K BV-C	
SP-9022	0511397130	Silent-bloc balancín  Goma-metal Ø60 x Ø105 x 145	BPW Series VB	
SP-9024	0511396050 S1 0203160100 S1	Silent-bloc barra tensor  Goma-metal Ø30 x Ø60 x 68	BPW	

Ref. Salanguera	Ref. Or.	Descripción	Modelo	
SP-9023		Silent-bloc barra tensor Goma-metal Ø24 x Ø60 x 70	BPW BAD	
SP-3060102	0203160600  ROR: 21222609 KÄSSBOHRER: 8241202905	Silent-bloc Ballesta Goma-metal Ø30 x Ø60 x 102	BPW	
SP-2460102	21224663	Silent-bloc Ballesta Goma-metal Ø24 x Ø60 x 102	BPW ROR-MERITOR	
SP-2460080	21225103 1611229	Silent-bloc Ballesta Goma-metal Ø24 x Ø60 x 80	BPW ROR-MERITOR	
SP-9025	0511393030  SAF: 4177301600	Silent-bloc barra tensor Goma-metal Ø36 x Ø65,5 x 68	BPW GALUCHO SAF	
SP-2457100102	174986.03  MERCEDES: 3713280250	Silent-bloc Ballesta Metal-goma-metal Ø24 x Ø57 x 100 x 102	BPW MERCEDES ROR-MERITOR	
SP-3057100103	0203169000	Silent-bloc Ballesta Metal-goma-metal Ø30 x Ø57 x 100 x 102	BPW	

Ref. Salanguera	Ref. Or.	Descripción	Modelo	
SP-3060098102	0203169000 S1  ROR-MERITOR: 21215601RS	Silent-bloc Ballesta Metal-goma-metal Ø30 x Ø60 x 98 x 102	BPW ROR-MERITOR	
SP-3057079082		Silent-bloc Ballesta Metal-goma-metal Ø30 x Ø57 x 79 x 82	BPW	
SP-305768	0203160100 S2 0511396050 S2	Silent-bloc Ballesta Metal-goma-metal Ø30 x Ø57 x 68	SERIES VB	
SP-3060070072	0203159800	Silent-bloc Ballesta Metal-goma-metal Ø30 x Ø60 x 70 x 72	BPW AAIRLIGHT II	
SP-2457078082		Silent-bloc Ballesta Metal-goma-metal Ø24 x Ø57 x 78 x 82	BPW	
SP-2460070072	0203142400	Silent-bloc Ballesta Metal-goma-metal Ø24 x Ø60 x 70 x 72	BPW AIRLIGHT II	
13.17.0700	09.801.08.12.0	KIT COMPLETO	BPW	
13.17.0701	03.320.38.29.0	1.-Arandela 59 x170 x4,5	ECO AIR COMPACT	
13.17.0702	03.281.34.12.0	2.-Placa alineación 107 x 85/70 x 6		
13.17.0703	02.031.43.80.0	3.-Silent-bloc 24 x132 x 112		
13.17.0704	03.379.00.39.0	4.-Soporte 60 x 83,5 x 44		
13.17.0705	03.340.14.33.0	5.-Bulón M24 x 171 / Ø 56		
13.17.0706	03.320.33.28.0	7.-Arandela 25 / 60 x 6		



Ref. Salanguera	Ref. Or.	Descripción	Modelo	
SP-9033	0318190100	Apoyo de ballesta  Ø25/59 x 90 x 25	BPW	
SP-9027	0318190060 0318190061 0318190020  SAF: 1169000301  KÄSSBOHRER: 8241000430	Apoyo de ballesta  112 x 158 x 64	BPW	
SP-9028	0318190050 0318190010  SAF: 1318100102  KÄSSBOHRER: 8241000422	Apoyo de ballesta  Ø24 x 69/74 x 110	BPW	
SP-9029	0235060100	Almohadilla de tope Ballesta de 100mm.  M12 x 81 x 81 x 30	BPW	
SP-9030	0235060200	Almohadilla de tope Ballesta de 100mm.  M12x1,5 x 75/42	BPW	

Ref. Salanguera	Ref. Or.	Descripción	Modelo	
13.30.0043	0535367090 0335367090	Cabeza tensor Rosca Izquierda	BPW SERIES VB	
13.30.0042	0535367080 0335364080	Cabeza tensor Rosca derecha	BPW SERIES VB	
13.30.0044	0544370920	Tensor regulable Corto 320 / 380	BPW SERIES VB	
13.30.0045	0544370770	Tensor regulable Largo 450 / 500	BPW SERIES VB	
13.30.0040		Tensor fijo Corto Largo 420mm.	BPW	
13.30.0041		Tensor fijo Largo Largo 515mm.	BPW	
13.30.0001	Husillos tensor	Ø36/200 x 200		
13.30.0002		Ø36/200 x 220		
13.30.0003		Ø36/200 x 260		
13.30.0004		Ø36/200 x 310		
13.30.0005		Ø36/200 x 350		
13.30.0006		Ø36/200 x 405		



## FRUEHAUF-SMB



Ref. Salanguera	Ref. Or.	Descripción	Modelo	
BPFR-11	UJB0154001-31310	Balancín  480mm.	FRUEHAUF	
BP-5011	UJA0324001-31200	Bulón balancín Completo	FRUEHAUF	
BP-5013	UJA0032001-31117	Arandela 25x96x6		
BP-5014	AUJ0097001-31119	Arandela 51x96x2		
BP-5012 BP-5012/1	UJA0034001-31198 Cabeza hexagonal	Bulón tensor Completo	FRUEHAUF	
BP-5016	UJA0035001-31251	Arandela 25x65x6		
BP-5015	UJA0097002-31253	Arandela 325x65x2		
CAPUCHINOS:	CP-121202611 CP-121402611 CP-121602611 CP-121802611 CP-122002611 CP-141802611	12 x 120 12 x 140 12 x 160 12 x 180 12 x 200 14 x 180	Diámetro: Ø12 / Ø14 Ancho cabeza: Ø26 Altura cabeza: 11mm.	
SP-9031	UJA0033001	Silent-bloc brazo tensor  Ø32 x Ø55,5 x 58,5	FRUEHAUF	
SP-9032	UJA0030001	Silent-bloc Balancín  Ø52 x Ø90 x 112	FRUEHAUF	
SP-3068100104	M001502 R.V.I.: 5000815738 SAF: 4177301000	Silent-bloc ballesta Metal-goma-metal Ø30 x Ø68 x 100 x 104	FRUEHAUF	

Ref. Salanguera	Ref. Or.	Descripción	Modelo
SOFR-0008	M0045062	Soporte asiento ballesta	SMB
			
SOFR-0006	9093211	Soporte ballesta Izquierdo 365mm.	
			
SOFR-0006/1	9093212	Soporte ballesta Derecho 365mm.	
			
SOFR-0001	UJA0438001-31225	Almohadilla asiento abarcón	
			
SOFR-0002	UJA0050001-31276	Soporte central	
			
SOFR-0003	31275	Soporte delantero	
			
SOFR-0004	UJA0052001-31197	Soporte trasero	
			

Ref. Salanguera	Ref. Or.	Descripción	Modelo	
SPFR-0005	UJA0038001-9031260	Soporte tirante		
SOFR-0007	UJA0039-WA3700	Soporte asiento ballesta	FRUEHAUF SMB	
A-3012023	MO49351	Arandela SMB Ø30 x Ø120 x 23	FRUEHAUF SMB	
13.30.0064	UJA0024001-31102	Tensor regulable Corto Usillo de 200mm.		
13.30.0065	UJA0024001-31258	Tensor regulable Largo Usillo de 260mm.		
13.30.0062	UJA0025002-31104	Cabeza tensor Rosca Derecha		
13.30.0063	UJA0025001-31103	Cabeza tensor Rosca Izquierda		

Ref. Salanguera	Ref. Or.	Descripción	Modelo
13.30.0060	UJA0023002-31110	Tensor fijo Corto Largo 390mm.	
13.30.0061	UJA0023002-31257	Tensor fijo Largo Largo 450mm.	

## KÄSSBOHRER





Ref. Salanguera	Ref. Or.	Descripción	Modelo
SP-3060102	8241202905 ROR: 21222609 BPW: 0203160600	Silent-bloc Ballesta Goma-metal Ø30 x Ø60 x 102	
SP-306582	82312000300	Silent-bloc Ballesta Metal-goma-metal Ø30 x Ø65,5 x 82	
SP-3065097102	4771327000 MONTENEGRO: 0362358 GIGANT: F00021347	Silent-bloc Ballesta Metal-goma-metal Ø30 x Ø65 x 97 x 102	
BB-4301	4771389000	Bulón silent-bloc Ballesta de 80mm. Ø68 x 77/170	
BB-4302	4771388000	Bulón silent-bloc Ballesta de 100mm. Ø68 x 97/190	
SP-9027	8241000430 SAF: 1169000301 BPW: 0318190060	Apoyo de ballesta 112 x 158 x 64	
SP-9028	8241000422 SAF: 1169000301 BPW: 0318190050	Apoyo de ballesta Ø24 x 69/74 x 110	

LECIÑENA-GIGANT

WEWELER

Ref. Salanguera	Ref. Or.	Descripción	Modelo	
BPLE-21R	411080000	Balancín Con casquillo	LECIÑENA	
BP-5022	3110272201	Bulón balancín Macizo Ø60 x 210	LECIÑENA	
BP-5023	312026	Bulón tirante c/t Ø24 x 170	LECIÑENA	
BP-5024	120025100010	Bulón tirante c/t Ø30 x 170	LECIÑENA	
13.10.0004	120025000003	Bulón c/t M27/200 x Ø30 x 186	WEWELER	
13.10.0005	120025000185	Bulón c/t M27/200 x Ø30 x 170	WEWELER	
BP-5026	ARANDELAS ESCALONADAS	Ø24 Pequeña	LECIÑENA	
BP-5027		Ø24 Grande		
BP-5028		Ø30 Grande		

Ref. Salanguera	Ref. Or.	Descripción	Modelo	
BP-5030.205	00160173  KÄSSBOHRER: 8241999120	Bulón de ballesta M27/1,5 x Ø30 x 205	GIGANT SF LK	
BP-5030.230	00160182  KÄSSBOHRER: 8241135612	Bulón de ballesta Ballesta de 100mm. M27/1,5 x Ø30 x 231	GIGANT SF	
BP-5030/1	00149017 120025000063  KÄSSBOHRER: 8241135614	Arandela excéntrica BP-5030.205 Ø30 x 47/54 x 25	GIGANT SF LK	
BP-5030/4	120025000089	Arandela excéntrica BP-5030.230 Ø30 x 47/54 x 34	GIGANT SF	
BP-5030/2	120025000065	Arandela distanciadora Ø31 x Ø58 x 8	GIGANT SF LK	
BP-5030/3	00289035	Casquillo soldable Ø45 x 75/80 x 15,5	GIGANT SF	
13.10.0001	12002500023	Placa de alineación	WEWELER	
13.10.0008	1025586	Placa alineación Ø31 x 125 x 100	SCHMITZ - CARGOBULL	

Ref. Salanguera	Ref. Or.	Descripción	Modelo	
SP-98072	00198072	Silent-bloc ballesta Metal-goma-metal Ballesta de 80mm. Ø30 x Ø57,5 x 75 x 96	GIGANT SF	
SP-99072	00199072	Silent-bloc ballesta Metal-goma-metal Ballesta de 100mm. Ø30 x Ø57,5 x 96 x 116	GIGANT SF LK	
SP-3065097102	F00021347  MONTENEGRO: 0362358 KÄSSBOHRER: 4771327000	Silent-bloc ballesta Metal-goma-metal  Ø30 x Ø65 x 97x 102	GIGANT	
SP-30069084	00196078	Silent-bloc ballesta Metal-goma  Ø30 x Ø69 x 83,5	SAE-GIGANT	
SP-9058	120025100012	Casquillo soporte Goma-nilón  Ø30 x Ø50 x 35	LECIÑENA	
SP-9059	120025100013	Casquillo tirante Goma-nilón  Ø30 x Ø50 x 70	LECIÑENA	
CAPUCHINOS:	CP-141002525 CP-141202525 CP-141402525 CP-141602525 CP-141802525 CP-142002525 CP-142202525	14 x 100 14 x 120 14 x 140 14 x 160 14 x 180 14 x 200 14 x 220	Diámetro: Ø14 Ancho cabeza: Ø25 Altura cabeza: 25mm.	

# Suministros Salanguera LECIÑENA-GIGANT-WEWELER

Ref. Salanguera	Ref. Or.	Descripción	Modelo	
SOLE-0001	3100411	Soporte central	LECIÑENA	
SOLE-0002	3100421	Soporte delantero	LECIÑENA	
SOLE-0003	3100431	Soporte trasero	LECIÑENA	
SOLE-0006	3120201	Soporte tirante 80mm	LECIÑENA	
SOLE-0007	3220211	Soporte tirante 40mm.		
SOLE-0008	3120221	Soporte tirante 20mm.		
SOLE-0004/1	120025100066	Placa asiento abarcón	LECIÑENA	
SOLE-0004	3110181	Placa asiento abarcón	LECIÑENA	
13.10.0003	120025000014	Altura: 310 mm.	WEWELER	
13.10.0006	120025000194	Altura: 360 mm.		
13.10.0007		Altura: 390 mm.		

# Suministros Salanguera LECIÑENA-GIGANT-WEWELER

Ref. Salanguera	Ref. Or.	Descripción	Modelo	
13.30.0084		Tensor regulable 427mm.	LECIÑENA	
13.30.0085		Tensor regulable 518mm.	LECIÑENA	
13.30.0082	120025100117	Cabeza tensor Rosca Derecha	LECIÑENA	
13.30.0083	120025100118	Cabeza tensor Rosca Izquierda	LECIÑENA	
13.30.0080		Tensor fijo 427mm.	LECIÑENA	
13.30.0081		Tensor fijo 518mm.	LECIÑENA	
13.30.0007		Tuerca 36/200 Derecha	LECIÑENA	
13.30.0008		Tuerca 36/200 Izquier.		

## MONTENEGRO





Ref. Salanguera	Ref. Or.	Descripción	Modelo	
BPMO-31	0501145	Balancín c/c 80mm.	MONTENEGRO	
BPMO-31/1	51002187	Balancín c/c 100mm.	MONTENEGRO	
BP-5031	0512621	Bulón balancín Macizo Ø58 x 220	MONTENEGRO	
BP-5031/1		Bulón balancín Hueco Ø58 x 220	MONTENEGRO	
BP-5031/2	51002188	Bulón balancín Balancín 100mm. Ø58 x 248	MONTENEGRO	
BP-22200140		22/200 X 140	MONTENEGRO	
BP-22200150	0511238	22/200 X 150		
BP-22200160	0501274	22/200 X 160		
BP-22200170	0501460	22/200 X 170		
SP-9061		Casquillo nilón balancín 80mm.	MONTENEGRO	
SP-9065		Casquillo nilón balancín 100mm.		

Ref. Salanguera	Ref. Or.	Descripción	Modelo	
SP-9062	0511264	Silent-bloc balancín 80mm.	MONTENEGRO	
SP-9063	0501100	Silnet-bloc tiranta	MONTENEGRO	
SP-3065097102	0362358 699320  KÄSSBOHRER: 4771327000  GIGANT: F00021347	Silent-bloc ballestón Metal-goma-metal  Ø30 x Ø65 x 97 x 102	MONTENEGRO	
SP-3065066071	050002890 B	Silent-bloc ballestón Metal-goma-metal Ballesta de 70mm. Ø30 x Ø65 x 66 x 71	MONTENEGRO	
SOMO-0001		Soporte ballesta Trasero	MONTENEGRO	
SOMO-0002		Soporte ballesta Delantero	MONTENEGRO	
SOMO-0003		Soporte ballesta Central	MONTENEGRO	

Ref. Salanguera	Ref. Or.	Descripción	Modelo	
SOMO-0008		Soporte asiento Ballesta de 75mm.	MONTENEGRO	
SOMO-0009		Soporte asiento Ballesta de 100mm.	MONTENEGRO	
SOMO-0010	0501278	Soporte asiento Ballesta de 75mm.	MONTENEGRO	
SOMO-2618	050002618	Placa inferior 175mm.	MONTENEGRO	
SOMO-2619	050002619	Placa inferior 155mm.	MONTENEGRO	
SOMO-0011R		Soporte DERECHO Suspensión 70mm.	MONTENEGRO Adaptable a MERCEDES	
SOMO-0011L		Soporte IZQUIERDO Suspensión 70mm.	MONTENEGRO Adaptable a MERCEDES	

PEPIN

Ref. Salanguera	Ref. Or.	Descripción	Modelo	
BPPE-61		Balancín 80mm.	PEPIN	
BP-5051		Bulón balancín Ø50 x 210	PEPIN	
BP-5052		Bulón balancín Ø50 x 175	PEPIN	
BP-5053	Bulón tensor	Ø25,4 x 143	PEPIN	
BP-5054	Bulón tensor	Ø25,4 x 169	PEPIN	
BP-5055	Bulón tensor	Ø22 x 140	PEPIN	
BP-5056	Bulón tensor	Ø22 x 170	PEPIN	
BP-5057	Bulón tensor	Ø24 x 122	PEPIN	
BP-5058	Bulón tensor	Ø24 x 150	PEPIN	
SP-9071		Silent-bloc balancín	PEPIN	
SP-9072	Silent-bloc tensor	Ø22,5 x Ø47,5 X 74	PEPIN	
SP-9073		Ø24,5 x Ø47,5 X 74	PEPIN	
SP-9074		Ø25,4 x Ø47,5 x 74	PEPIN	

## PRIMBALL

Ref. Salanguera	Ref. Or.	Descripción	Modelo
BPPR-71		Balancín 420mm.	
BPPR-72		Balancín 520mm.	
BPPR-73		Balancín 570mm.	
BP-5041		Bulón balancín Cabeza descentrada Ø45 x 215	
BP-30350140	Bulón tensor c/t	Ø30/350 x 140	
BP-30350150	Bulón tensor c/t	Ø30/350 x 150	
BP-30350160	Bulón tensor c/t	Ø30/350 x 160	
SP-9081		Silent-bloc balancín  Ø45 x Ø83 x 107	
SP-9082		Silent-bloc tensor  Ø30 x Ø60 x 50	

## ROR-MERITOR





Ref. Salanguera	Ref. Or.	Descripción	Modelo
BPRO-05	21203141	Balancín Silent-bloc CONICO	
			
BP-5061	21206000	Bulón balancín Completo M24/300 x Ø41 x 290	Series SMT Series SM Series T
			
BP-5061/1	21206253	Bulón balancín Completo Eje autodireccional Ø41 x 430	Series SMT
			
BP-5063	21202094	Bulón Tensor Completo M24/300 x Ø31,5 x 162	Series SMT
			
BP-24200190	21222230	Bulón Amortiguador c/t M24/200 x 190	ROR
			
TA-22140	21015626	Bulón c/t M22/150 x 140	Series M Series SM
			
BP-30350200	21222234	Bulón c/t M30/350 x 200	FL 9000 FL 9000L / M / H / HL FL 11000 FL 11000 / 150 FL 11000 L/D/B/LB/CT/CS FP 11000
			

Ref. Salanguera	Ref. Or.	Descripción	Modelo	
BP-30350290	21223744	Bulón c/t M30/350 x 290	FL 9000 M FL 11000	
TA-24300	21222233	Bulón c/t M24/200 x 300	FP 11000 FL 9000 M FL 11000 FL 11000 CS	
SP-9091	21011745	Silent-bloc tensor Ø22 x Ø48,5 x 75	Series M Series SM	
SP-9096	120025100274	Ø28 x Ø69 x 58		
SP-9091/1	21202104	Silent-bloc tensor Ø32 x Ø55,5 x 58,5	Series SMT	
SP-9092	21011746	Silent-bloc Balancín Ø51 x Ø79 x 106	Series M	
SP-9093	21020676 503624	Silent-bloc Balancín Ø41,5 x Ø70/Ø89 x 113	Series SMT Series SM Series T	
SP-2460102	21224663	Silent-bloc ballesta Goma-metal Ø24 x Ø60 x 102	FL 9000 FL 9000 L FL 9000 M FL 9000 NB FL 9000 HLL	

Ref. Salanguera	Ref. Or.	Descripción	Modelo	
SP-3060102	21222609  BPW: 0203160600  KÄSSBOHRER: 8241202905	Silent-bloc Ballesta  Goma-metal  Ø30 x Ø60 x 102	FL 9000 FL 9000 L / M FL 11000 FL 11000 / 150 FL 11000 L/D/B/LB/CS	
SP-2460080		Silent-bloc Ballesta  Goma-metal  Ø24 x Ø60 x 80		
SP-306045	21223742	Silent-bloc elevador  Goma-metal  Ø30 x Ø60 x 45	FL 9000 M FL 11000	
SP-246045	21227205	Silent-bloc elevador  Goma-metal  Ø24 x Ø60 x 45	FL 9000 M FL 11000	
SP-244858	21224754	Silent-bloc Ballesta  Goma-metal  Ø24 x Ø48 x 58	Series TE, TH, TM, TA, TC Series LM / LC / LCM Series T, U	
SP-3068100104	21215601 RS	Silent-bloc ballesta  Metal-goma-metal  Ø30 x Ø68 x 100 x 104		
SP-3057100103	21225601 R	Silent-bloc ballesta  Metal-goma-metal  Ø30 x Ø57 x 100 x 103		

Ref. Salanguera	Ref. Or.	Descripción	Modelo
SP-2457100102		Silent-bloc ballesta Metal-goma-metal Ø24 x Ø57 x 100 x 102	
SP-9094	21212426	Silent-bloc excéntrico Ø22 x Ø63 x 66 x 72	
SP-9095	21212489	Silent-bloc excéntrico Ø20 x Ø63 x 66 x 72	
SP-24150120	21226997 21230041	Silent-bloc brazo Oscilante Ø24,5 x Ø150 x 120	
SP-24150120 AR	21226663	Arandela nylon 64 x 191 x 7	
ARROR-3521051	21224386	Arandela fijación Ø24 x Ø100 x 5	
ARROR-3521052	21225162	Arandela fijación Ø24 x Ø100 x 3	
ARROR-3521700	2500700	Arandela fijación Ø30 x Ø80 x 5	

Ref. Salanguera	Ref. Or.	Descripción	Modelo
ARROR-3521084	21228664	Arandela excéntrica Con alojamiento  Ø24 x Ø90 x 15	
ARROR-3521085	21228663	Arandela centrada  Ø24 x Ø90 x 15	
ARROR-3521086	21222221	Arandela alineación Excéntrica Ø30mm.	
ARROR-3521087	21222287	Arandela alineación Centrada Ø30mm.	
ARROR-3521088	6800129	Casquillo anclaje elevador	
ARROR-3521089	6800130	Casquillo anclaje elevador	
ARROR-3521090		Arandela soldable  Ø 24mm	

Ref. Salanguera	Ref. Or.	Descripción	Modelo	
SOROR-6414D	21226414R	Derecho 375mm.	FL 9000 NB	
SOROR-6414I	21226414L	Izquierdo 375mm.		
SOROR-6416D	21226416R	Derecho 425mm.	FL 9000 NB	
SOROR-6416I	21226416L	Izquierdo 425mm.		
SOROR-4781D	21224781R	Derecho 310mm.	FL 9000 NB	
SOROR-4781I	21224781L	Izquierdo 310mm.		
SOROR-4783D	21224783R	Derecho 350mm.	FL 9000 NB	
SOROR-4783I	21224783L	Izquierdo 350mm.		
SOROR-7232D	21227232R	Derecho 475mm.	Series FL	
SOROR-7232I	21227232L	Izquierdo 475mm.		
SOROR-0010		Placa reglaje soportes	Todos los modelos	
		Asiento de ballesta		
SOROR-7883R	21227883R	Derecho		
SOROR-7883L	21227883L	Izquierdo		
				Derecho Izquierdo

**GALUCHO**

Ref. Salanguera	Ref. Or.	Descripción	Modelo	
BPGA-00001	3340214700	Balancín completo	GALUCHO	
BP-5072		Bulón balancín Ø 70mm.	GALUCHO	
BP-36400155	04343202988	36/400 x 155	GALUCHO	
BP-36400185	04343202888	36/400 x 185		
BP-36400215		36/400 x 215		
SP-9025	4177301600	Silent-bloc tensor  Ø36 x Ø67 x 67	GALUCHO	







SAF-SAUER

Ref. Salanguera	Ref. Or.	Descripción	Modelo	
SP-3068100104	4177301000  R.V.I.: 5000815738  FRUEHAUF: M001502	Silent-bloc ballesta  Metal-goma-metal  Ø30 x Ø68 x 100 x 104	AR 112 / 113 / 211 / 212 AR 311 / EM 311 AR 311 E / EM 311 E AR 311 EH / EM 311 EH AR 311 H / EM 311 H AR 314 / EO 314 AR 314 E / EO 314 E AR 314 E / EO 314 E	
SP-9102	1177200200	Silent-bloc balancín  Ø50,7 x 69/91 x 119	INTRAAX INTRADISC PLUS	
SP-9103	1177100102	Silent-bloc tensor  Ø30 x 55 x 62	VDS 16 VDS 20 VDZ 16 VDZ 20 VDS 24 K VDS 16 VDS 20 VDS 24 VL 230 T	
SB-2459107	41770008000  VOLVO: 1696042	Silent-bloc ballesta  Metal-goma-metal  Ø24 x Ø59 x 107		
SP-307474	4177303300	Silent-bloc ballesta  Metal-goma-metal  Ø30 x Ø74 x 74	Suspensión Neumática	
SP-9104	4177302600	1.-Silent-bloc brazo	Ø31.5 x Ø152 x 171	
AR-23381	4101200200	2.-Ara. Distanciadora	Ø23 x 38	
AR-23382	4123000200	3.-Ara. Distanciadora	Ø23 x 38	
TA-22150250	4343205510	4.-Tornillo Amarre c/t	Ø22/150 x 250	
SP-9104 KIT	4177302600 S	Kit brazo Intraplus  Completo	INTRAAX XO INTRAAX XU INTRADISC PLUS "PO" INTRADISC PLUS "PU"	



Ref. Salanguera	Ref. Or.	Descripción	Modelo	
SP-9105	4177302800	Silent-bloc brazo Intraplus  Ø31,5 x Ø155x 114	SKRLB 9019 IO / IU SKRLB 9022 IO / IU INTRADISC PLUS "IU" INTRADICS PLUS "IO"	
SP-9105 KIT	4177302800 S	Kit brazo intraplus  Completo	SKRLB 9019 IO/ IU SKRLB 9022 IO / IU INTRADISC PLUS "IU" INTRADISC PLUS "IO"	
SP-9105 AR	4331502900	1.-Arandela nilón	Ø60 x Ø170 x 4,7	
AR-31201	1123000101	2.-Ara. Distanciadora	Ø31 x 20	
AR-31202	1101200100	3.-Ara. Distanciadora	Ø31 x 20	
TA-30350205	4343104888	4.-Tornillo Amarre c/t	Ø30/350 x 205	
SP-9027	1169000301	Apoyo de ballesta  112 x 158 x 64	VDS 16 VDS 20 VDS 24 VDS 24 K VDZ 16 VDZ 20 VDZ 22 VLZ 30 T VLZ 40 T	
SP-9028	1318100102	Apoyo de ballesta  Ø24 x 69/74 x 110	VDS 16 VDS 20 VDS 24 VDS 24 K VDZ 16 VDZ 20 VDZ 22 VLZ 30 T VLZ 40 T	
13.17.0710	1072201700	Casquillo de plástico  Ø70 x Ø92 x 45	VLZ 30 T VLZ 40 T VRZ 20 VRX 20 T	
13.17.0711	2095203900	Cilindro ballesta  Ø15 x Ø40 x 101	VDS 16 VDS 20 VRZ 20 VDS 20 VDS 24 VDS 24 K VDZ 20 VLS 22	

Ref. Salanguera	Ref. Or.	Descripción	Modelo	
123123	2183082600	Soporte 255 / 335	SAF	
123123	2183082700	Soporte 300 / 385	SAF	
1313232312	4177300800	Silent-bloc ballesta Ø30 x Ø50 x 101	SAUER ACHSEN	
123545545	1022100301 1022100302	Placa desgaste	SAUER ACHSEN	
13112313121323	4177002000	Silent-bloc ballesta Ø20 x Ø68 x 102	SAUER ACHSEN	

## TRAILOR



Ref. Salanguera	Ref. Or.	Descripción	Modelo	
BPTR-81	6502875 D	Balancín corto 420mm	TRAILOR	
BPTR-82	6502883 D	Balancín largo 570mm	TRAILOR	
SP-9111	2210000 Z	Silent-bloc	TRAILOR	
CB-2032108	2035000 J	Casquillo acero		
TA-20140	2033000 M	Tornillo 20 x 140		
SP-9111/1	6127000 M	Silent-bloc tensor  Ø25 x Ø48,5 x 76	TRAILOR	
SP-9112	6115000 X	Silent-bloc balancín	TRAILOR	
BP-5081	6113000 A	Tornillo bulón		

ARANDELAS  
CAPUCHINOS 10Ø

Ref. Salanguera	Ref. Or.	Descripción	Modelo
ARANDELAS ACERO:	ACH-3310	Ø33 x Ø60 x 1	
	ACH-3315	Ø33 x Ø60 x 1,5	
	ACH-3320	Ø33 x Ø60 x 2	
	ACH-3330	Ø33 x Ø60 x 3	
	ACH-3030	Ø38 x Ø70 x 3	
ARANDELAS CINCADAS:	ACH-1020	Ø10 x Ø20 x 2	
	ACH-1320	Ø13 x Ø20 x 3	
	ACH-1630	Ø16 x Ø30 x 3	
	ACH-2030	Ø20 x Ø36 x 3	
	ACH-2230	Ø22 x Ø38 x 3	
	ACH-2430	Ø24 x Ø38 x 3	
	ACH-3130	Ø31 x Ø56 x 4	
CAPUCHUNOS:	CP-10060159	10 x 60	Diámetro: Ø10  Ancho cabeza: Ø15  Altura cabeza: 9mm  
	CP-10080159	10 x 80	
	CP-10100159	10 x 100	
	CP-10120159	10 x 120	
	CP-10140159	10 x 140	
	CP-10160159	10 x 160	
	CP-10180159	10 x 180	
	CP-10200159	10 x 200	
	CP-10220159	10 x 220	
	CP-10240159	10 x 240	
	CP-10260159	10 x 260	
	CP-10280159	10 x 280	



## SUPLEMENTOS DE ABARCÓN CADENAS ELEVADOR EJE

Ref. Salanguera	Ref. Or.	Descripción	Modelo
SUPLEMENTOS DE ABARCÓN:	SA-132510	Ø13 x Ø25 x 10	
	SA-132520	Ø13 x Ø25 x 20	
	SA-152510	Ø15 x Ø25 x 10	
	SA-152520	Ø15 x Ø25 x 20	
	SA-173010	Ø17 x Ø30 x 10	
	SA-173020	Ø17 x Ø30 x 20	
	SA-193410	Ø19 x Ø34 x 10	
	SA-193420	Ø19 x Ø34 x 20	
	SA-213610	Ø21 x Ø36 x 10	
	SA-213620	Ø21 x Ø36 x 20	
	SA-233810	Ø23 x Ø38 x 10	
	SA-233820	Ø23 x Ø38 x 20	
	SA-254210	Ø25 x Ø42 x 10	
	SA-254220	Ø25 x Ø42 x 20	
SA-285010	Ø28 x Ø50 x 10		
SA-285020	Ø28 x Ø50 x 20		
SA-25 MAN	Ø25 Cónico		
SA-28 MAN	Ø28 Cónico		
CADENAS EJE ELEVADOR:	CADENA 5	5 eslabones	d = 18 mm.
	CADENA 6	6 eslabones	t = 63 mm. b1 = 26 mm.
	CADENA 7	7 eslabones	b2 = 61 mm.

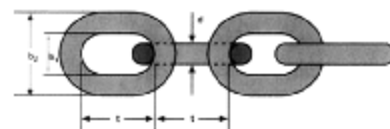

TORNILLOS DE ACERO

TUERCAS

Ref. Salanguera	Ref. Or.	Descripción	Modelo
TORNILLOS ACERO 12.9	TA-10020	M10/150 x 20	
	TA-10030	M10/150 x 30	
	TA-10035	M10/150 x 35	
	TA-10040	M10/150 x 40	
	TA-10050	M10/150 x 50	
	TA-10060	M10/150 x 60	
	TA-10070	M10/150 x 70	
	TA-10080	M10/150 x 80	
	TA-10090	M10/150 x 90	
	TA-10100	M10/150 x 100	
	TA-10120	M10/150 x 120	
		TA-12030	
	TA-12035	M12/150 x 35	
	TA-12040	M12/150 x 40	
	TA-12050	M12/150 x 50	
	TA-12060	M12/150 x 60	
	TA-12070	M12/150 x 70	
	TA-12080	M12/150 x 80	
	TA-12100	M12/150 x 100	
	TA-12120	M12/150 x 120	
	TA-12140	M12/150 x 140	
	TA-12160	M12/150 x 160	
	TA-12200	M12/150 x 200	
	TA-14030	M14/150 x 30	
	TA-14040	M14/150 x 40	
	TA-14050	M14/150 x 50	
	TA-14060	M14/150 x 60	
	TA-14070	M14/150 x 70	
	TA-14080	M14/150 x 80	
	TA-14100	M14/150 x 100	
	TA-14120	M14/150 x 120	
	TA-14140	M14/150 x 140	
	TA-14160	M14/150 x 160	
	TA-14180	M14/150 x 180	
	TA-16040	M16/150 x 40	
	TA-16050	M16/150 x 50	
	TA-16060	M16/150 x 60	
	TA-16070	M16/150 x 70	
	TA-16080	M16/150 x 80	
	TA-16100	M16/150 x 100	
	TA-16120	M16/150 x 120	
	TA-16140	M16/150 x 140	
	TA-16160	M16/150 x 160	
	TA-16180	M16/150 x 180	
	TA-16200	M16/150 x 200	
	TA-16220	M16/150 x 220	
	TA-16240	M16/150 x 240	
	TA-16260	M16/150 x 260	

Ref. Salanguera	Ref. Or.	Descripción	Modelo
TORNILLOS ACERO 12.9	TA-18130	M18/150 x 130	
	TA-18140	M18/150 x 140	
	TA-18160	M18/150 x 160	
	TA-18180	M18/150 x 180	
	TA-18200	M18/150 x 200	
	TA-18220	M18/150 x 220	
	TA-18240	M18/150 x 240	
	TA-18260	M18/150 x 260	
	TA-18280	M18/150 x 280	
	TA-18300	M18/150 x 300	
TA-18320	M18/150 x 320		
	TA-20140	M20/150 x 140	
	TA-20160	M20/150 x 160	
	TA-20180	M20/150 x 180	
	TA-20200	M20/150 x 200	
	TA-20220	M20/150 x 220	
	TA-20240	M20/150 x 240	
	TA-20260	M20/150 x 260	
	TA-20280	M20/150 x 280	
	TA-20300	M20/150 x 300	
	TA-20320	M20/150 x 320	
	TA-22120	M22/150 x 120	
	TA-22140	M22/150 x 140	
	TA-22150	M22/150 x 150	
	TA-22180	M22/150 x 180	
	TA-22200	M22/150 x 200	
	TA-22220	M22/150 x 220	
	TA-22240	M22/150 x 240	
	TA-22260	M22/150 x 260	
	TA-22280	M22/150 x 280	
	TA-22300	M22/150 x 300	
	TA-22380	M22/150 x 380	
	TA-22400	M22/150 x 400	
	TA-22420	M22/150 x 420	
	TA-24090	M24/200 x 90	
	TA-24140	M24/200 x 140	
	TA-24150	M24/200 x 150	
	TA-24200	M24/200 x 200	
	TA-24220	M24/200 x 220	
	TA-24240	M24/200 x 240	
	TA-24260	M24/200 x 260	
	TA-24280	M24/200 x 280	
	TA-24300	M24/200 x 300	
	TA-27120	M27/200 x 120	
	TA-27130	M27/200 x 130	

Ref. Salanguera	Ref. Or.	Descripción	Modelo
TUERCAS DE ABARCÓN:	TAM-10150	M10/150	
	TAM-12150	M12/150	
	TAM-14150	M14/150	
	TAM-16150	M16/150	
	TAM-18150	M18/150	
	TAM-20150	M20/150	
	TAM-22150	M22/150	
	TAM-24150	M24/150	
	TAM-24200	M24/200	
	TAM-24300	M24/300	
	TAM-27200	M27/200	
	TAM-30200	M30/300	
TAM-36300	M36/300		
TUERCAS DE ABARCÓN (SAE):	TAS-11001	7/16	
	TAS-11002	1/2	
	TAS-11003	9/16	
	TAS-11004	5/8	
	TAS-11005	3/4	
	TAS-11006	7/8	
	TAS-11007	1"	
	TAS-11008	1" 1/4	
	TAS-11009	1" 1/2	
TUERCAS BAJAS C-10:	TC10-08125	8/125	
	TC10-10150	10/150	
	TC10-12150	12/150	
	TC10-14150	14/150	
	TC10-16150	16/150	
	TC10-18150	18/150	
	TC10-20150	20/150	
	TC10-22150	22/150	
TUERCAS BAJAS DIN 938.8:	TSM-08125	8/125	
	TSM-10150	10/150	
	TSM-12150	12/150	
	TSM-14150	14/150	
	TSM-16150	16/150	
	TSM-18150	18/150	
	TSM-30200	30/200	
TUERCAS AUTOBLOCANTES:	TNM-10150	10/150	
	TNM-12150	12/150	
	TNM-14150	14/150	
	TNM-14200	14/200	
	TNM-16150	16/150	
	TNM-18150	18/150	
	TNM-20150	20/150	
	TNM-22150	22/150	
	TNM-22200	22/200	
	TNM-24150	24/150	
	TNM-24200	24/200	
	TNM-24300	24/300	
	TNM-27200	27/200	
	TNM-30150	30/150	
	TNM-30350	30/350	
TNM-42300	42/300		